



*43UT570H0UA	65UT570H0UB	65UT570H9UB
49UT570H0UA	43UT570H9UA	49UT577H0UA
50UT570H0UA	50UT570H9UA	55UT577H0UA
55UT570H0UA	55UT570H9UA	65UT577H0UB

** When no suffix distinction (0UA, 0UB, 9UA, or 9UB) is required, this document simply refers to the UT570H/UT577H.*

Lodging Guest Interactive Pro:Centric[®] TVs

Commercial Mode Setup Guide

Note: Selected features shown in this guide may not be available on all models.

EXPERIENCED INSTALLER

First Use Wizard
pages 16 – 17

Custom Master TV Setup
pages 46 – 48

Cloning Procedures
pages 49 – 54

For Customer Support/Service, please call:

1-888-865-3026

The latest product information and documentation is available online at:

www.lg.com/us/business

MODEL and SERIAL NUMBER

The model and serial numbers of this TV are located on the back of the cabinet. For future reference, LG suggests that you record those numbers here:

Model No. _____ Serial No. _____



WARNING:

TO REDUCE THE RISK OF ELECTRIC SHOCK DO NOT REMOVE COVER (OR BACK). NO USER-SERVICEABLE PARTS INSIDE. REFER TO QUALIFIED SERVICE PERSONNEL.



The lightning flash with arrowhead symbol, within an equilateral triangle, is intended to alert the user to the presence of uninsulated “dangerous voltage” within the product’s enclosure that may be of sufficient magnitude to constitute a risk of electric shock to persons.



The exclamation point within an equilateral triangle is intended to alert the user to the presence of important operating and maintenance (servicing) instructions in the literature accompanying the appliance.

WARNING:

TO PREVENT FIRE OR SHOCK HAZARDS, DO NOT EXPOSE THIS PRODUCT TO RAIN OR MOISTURE.

WARNING:

This product contains chemicals known to the State of California to cause cancer and birth defects or other reproductive harm. **Wash hands after handling.**

NOTE TO CABLE/TV INSTALLER:

This reminder is provided to call the cable TV system installer’s attention to Article 820-40 of the National Electrical Code (U.S.A.). The code provides guidelines for proper grounding and, in particular, specifies that the cable ground shall be connected to the grounding system of the building, as close to the point of the cable entry as practical.

REGULATORY INFORMATION:

This equipment has been tested and found to comply with the limits for a Class B digital device, pursuant to Part 15 of the FCC Rules. These limits are designed to provide reasonable protection against harmful interference when the equipment is operated in a residential installation. This equipment generates, uses and can radiate radio frequency energy and, if not installed and used in accordance with the instruction manual, may cause harmful interference to radio communications. However, there is no guarantee that interference will not occur in a particular installation. If this equipment does cause harmful interference to radio or television reception, which can be determined by turning the equipment off and on, the user is encouraged to try to correct the interference by one or more of the following measures:

- Reorient or relocate the receiving antenna.
- Increase the separation between the equipment and receiver.
- Connect the equipment to an outlet on a circuit different from that to which the receiver is connected.
- Consult the dealer or an experienced radio/TV technician for help.

CAUTION:

Do not attempt to modify this product in any way without written authorization from LG Electronics U.S.A., Inc. Unauthorized modification could void the user’s authority to operate this product.

COMPLIANCE:

The responsible party for this product’s compliance is: LG Electronics U.S.A., Inc.
1000 Sylvan Avenue, Englewood Cliffs, NJ 07632, USA • Phone: 1-201-816-2000

Marketed and Distributed in the United States by LG Electronics U.S.A., Inc.
1000 Sylvan Avenue, Englewood Cliffs, NJ 07632

IMPORTANT SAFETY INSTRUCTIONS

1. Read these instructions.
2. Keep these instructions.
3. Heed all warnings.
4. Follow all instructions.
5. Do not use this apparatus near water.
6. Clean only with dry cloth.
7. Do not block any ventilation openings. Install in accordance with the manufacturer's instructions.
8. Do not install near any heat sources, such as radiators, heat registers, stoves, or other apparatus (including amplifiers) that produce heat.
9. Do not defeat the safety purpose of the polarized or grounding-type plug. A polarized plug has two blades with one wider than the other. A grounding-type plug has two blades and a third grounding prong. The wide blade or the third prong are provided for your safety. If the provided plug does not fit into your outlet, consult an electrician for replacement of the obsolete outlet.
10. Protect the power cord from being walked on or pinched, particularly at plugs, convenience receptacles, and the point where it exits from the apparatus.
11. Only use attachments/accessories specified by the manufacturer.
12. Use only with the cart, stand, tripod, bracket, or table specified by the manufacturer or sold with the apparatus. When a cart is used, use caution when moving the cart/apparatus combination in order to avoid injury from tip-over.



13. Refer all servicing to qualified service personnel. Servicing is required when the apparatus has been damaged in any way, such as power-supply cord or plug is damaged, liquid has been spilled or objects have fallen into the apparatus, the apparatus has been exposed to rain or moisture, does not operate normally, or has been dropped.
14. Never touch this apparatus or antenna during a thunder or lightning storm.
15. Do not apply pressure on or scratch the TV panel during handling. Do not press against the TV panel with your hand or a sharp object such as a nail, pencil, or pen.

16. Power Cord

Caution: Check the TV specifications in the Owner's Manual to determine power requirements.

Periodically examine the cord of your appliance, and if its appearance indicates damage or deterioration, unplug it, discontinue use of the appliance, and have the cord replaced with an exact replacement part by an authorized servicer. Protect the power cord from physical or mechanical abuse, such as twisting, kinking, or pinching or being closed in a door or walked upon. Pay particular attention to plugs, wall outlets, and the point where the cord exits the appliance.

Do not use a damaged or loose power cord. Be sure to grasp the plug when unplugging the power cord. Do not pull on the power cord to unplug the TV.

Do not stick metal objects or any other conductive material into the power cord. Do not touch the end of the power cord while it is plugged in.

17. Overloading

Do not connect too many appliances to the same AC power outlet as this could result in fire or electric shock. Do not overload wall outlets. Overloaded wall outlets, loose or damaged wall outlets, extension cords, frayed power cords, or damaged or cracked wire insulation are dangerous. Any of these conditions could result in fire or electric shock.

18. Outdoor Use/Wet Location



Warning: To reduce the risk of fire or electrical shock, do not expose this product to rain, moisture or other liquids.

Do not touch the TV with wet hands. Do not install this product near flammable objects such as gasoline or candles or expose the TV to direct air conditioning.

Do not expose to dripping or splashing and do not place objects filled with liquids, such as vases, cups, etc., on or over the apparatus (e.g., on shelves above the unit).

19. Grounding

(Except for devices that are not grounded) Ensure that you connect the earth ground wire to prevent possible electric shock (i.e., a TV with a three-prong grounded AC plug must be connected to a three-prong grounded AC outlet). If grounding methods are not possible, have a qualified electrician install a separate circuit breaker. Do not try to ground the unit by connecting it to telephone wires, lightning rods, or gas pipes.

20. Disconnect Device

The power plug is the disconnecting device. The power plug must remain readily accessible.

As long as this unit is connected to the AC wall outlet, it is not disconnected from the AC power source even if the unit is turned off.

(Continued on next page)

IMPORTANT SAFETY INSTRUCTIONS

(Continued from previous page)

21. Outdoor Antenna Grounding

If an outside antenna or cable system is connected to the product, follow the precautions below.

An outdoor antenna system should not be located in the vicinity of overhead power lines or other electric light or power circuits or where it can come into contact with such power lines or circuits as death or serious injury can occur.

Be sure the antenna system is grounded so as to provide some protection against voltage surges and built-up static charges.

Article 810 of the National Electrical Code (NEC) in the U.S.A. provides information with respect to proper grounding of the mast and supporting structure, grounding of the lead-in wire to an antenna-discharge unit, size of grounding conductors, location of antenna-discharge unit, connection to grounding electrodes, and requirements for the grounding electrode.

Antenna Grounding According to NEC, ANSI/NFPA 70

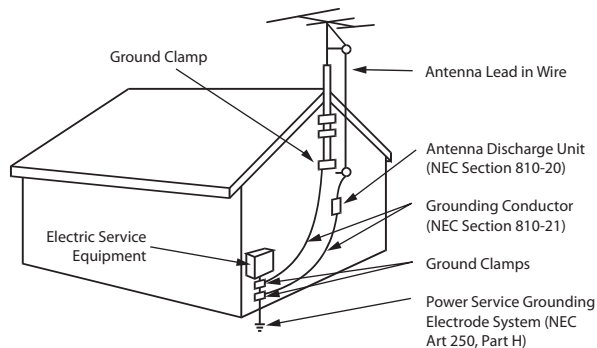

22. Cleaning

When cleaning, unplug the power cord and wipe gently with a soft cloth to prevent scratching. Do not spray water or other liquids directly on the TV as electric shock may occur. Do not clean with chemicals such as alcohol, thinners or benzene.

23. Transporting Product

Make sure the TV is turned off and unplugged and that all cables have been removed. It may take two or more people to carry larger TVs. Do not press against or put stress on the front panel of the TV.

24. Ventilation

Install the TV where there is proper ventilation. Do not install in a confined space such as a bookcase. Do not cover the TV with cloth or other materials (e.g., plastic) while it is plugged in. Do not install in excessively dusty places.

25. If you smell smoke or other odors coming from the TV or hear strange sounds, unplug the power cord, and contact an authorized service center.

26. Keep the product away from direct sunlight.

27. When mounting a TV on the wall, make sure that none of the electrical cabling bears any of the weight of the TV. Install in accordance with the manufacturer's instructions.

28. Do not install this product on a wall if it could be exposed to oil or oil mist. This may damage the product and cause it to fall.

29. Do not allow an impact shock or any objects to fall into the product, and do not drop objects onto the screen.

30. Do not touch the ventilation openings, as they may become hot while the TV is operating. This does not affect the performance of the product or cause defects in the product.

31. Do not use high voltage electrical equipment near the TV (e.g., a bug zapper). This may result in product malfunction.

32. Dot Defect

This panel is an advanced product that contains millions of pixels. In a very few cases, you could see fine dots on the screen while you are viewing the TV. Those dots are deactivated pixels and do not affect the performance and reliability of the TV.

33. Generated Sound

“Cracking”: A cracking noise that occurs while the TV is on or when it is turned off is generated by plastic thermal contraction due to temperature and humidity. This noise is common for products where thermal deformation is required.

Electrical circuit humming/panel buzzing: A low level noise is generated from a high-speed switching circuit, which supplies a large amount of current to operate a product. It varies depending on the product. This generated sound does not affect the performance and reliability of the product.

34. If the TV feels cold to the touch, there may be a small “flicker” when it is turned on. This is normal; there is nothing wrong with the TV. Some minute dot defects may be visible on the screen, appearing as tiny red, green, or blue spots. However, they have no adverse effect on the TV's performance. Avoid touching the screen or holding your finger(s) against it for long periods of time. Doing so may produce some temporary distortion effects on the screen.

35. Displaying a still image for a prolonged period of time may cause image burn-in. Avoid displaying a fixed image on the TV screen for an extended length of time.

Table of Contents

Safety Warnings	2	Exporting a Clone File	49
Important Safety Instructions	3–4	Importing a Clone File	51
Table of Contents	5	Cloud Configuration Tool Overview	55–60
Commercial Mode Overview	6–10	Creating an FTG Configuration File	55
Setup Checklist	6	File Manager Web Page Overview	58
Pass-through Mode	6	Channel Map Web Page Overview	59
FTG Mode	7	Installer Menu Web Page Overview	60
Application Tuning Mode / Pro:Centric Direct	9	IP Environment Setup	61–65
Determining the TV Operating Mode	10	Accessing the IP Environment Menu	61
Pro:Centric Operation	11–15	Network Configuration	61
Interactive Menu Features	11	Pro:Centric Setup	63
Interactive Menu Navigation	11	References	
Pro:Centric Java Application Setup	13	Remote Jack Pack / TV Connections & Setup	66
Pro:Centric Direct HTML Application Setup	14	Updating TV/PTC Software using a USB Memory Device	67–68
First Use Wizard	16–17	Downloading a Boot Logo Image using a USB Memory Device	69–70
Before You Begin	16	Power Consumption Settings	71–72
Initiate Configuration or Exit the First Use Wizard	16	TV Aux Input Configuration	73
Basic Settings Wizard	18–20	b -LAN Setup & Overview	74
Solution Settings / EZ-Manager Wizard	21–30	FTG Mode via EBL (Local Configuration)	75–76
TV Configuration Options	21	Auto Input(s) Sensing Feature	77–78
Zone and Room Number Assignments	22	RJP Model List & Input Auto-sensing Hierarchy	79
Network Settings	23	Restoring Factory Defaults on the TV(s)	80
Configure Pro:Centric Settings	24	Using the TV Zoning Feature	81–83
USB Configuration	29	UT570H/UT577H Rear and Side Jack Panels	84
Ez Download Utility	31–34	External Speaker/Audio Line Out Specifications	85
Before You Begin	31	Installer Remote Control Typical Key Functions	86
Accessing and Using the Ez Download Utility	31	TLT Communication Parameters	87–93
Installer Menu	35–45	Troubleshooting	94–95
Accessing the Installer Menu	35	General Troubleshooting	94
Navigating Within the Installer Menu	36	Commercial Mode Check / FTG Operation Troubleshooting	95
Modifying Installer Menu Settings	36	Glossary of Terms	96
Exiting the Installer Menu and Activating Settings	36	Document Revision History / Open Source Software Notice	97
Detailed Descriptions of Installer Menu Items	39	Back Cover	98
Custom Master TV Setup	46–48		
Before You Begin	46		
Clonable TV Setup Menu Features	46		
Custom Master TV Setup Procedure	47		
Cloning Procedures	49–54		

Notes

- Installer Menu content is intended for use primarily by qualified TV installation technicians.
- Refer to the applicable Owner's Manual and/or Easy Setup Guide for additional information on TV installation, specifications, maintenance, and safety instructions.
- Design and specifications subject to change without prior notice. This document provides examples of typical TV displays. Your displays may vary from those shown in this document.

Commercial Mode Overview

This document describes how to set up UT570H or UT577H Pro:Centric® TVs for Commercial Mode operation. LG commercial TV functionality is based on “ownership” of the Channel Map; that is, the Channel Map resides in the TV’s CPU, Protocol Translation Controller (PTC), or embedded *b*-LAN™ (EBL) module, or it resides in a Pro:Centric application or an external device from the solution provider.

These TV models support several different operational modes: LG’s Free-To-Guest (FTG) Mode via the TV CPU, FTG Mode via the TV’s EBL module, Application Tuning Mode (ATM) with Pro:Centric application, or Pass-through Mode (default). When in Pass-through Mode, these TV models can also be externally controlled via Multiple Protocol Interface (MPI) or TV-Link Tuner (TLT) interface (RS-232C).

Setup Checklist

Note: This document provides information specific to Commercial Mode operation. Refer to the Owner’s Manual and/or Easy Setup Guide for information on TV installation and hardware and cable connections.

Installation

- ___ Unpack TV and all accessories.
 - ___ Install batteries in the Installer Remote.
 - ___ Install TV on VESA mount or stand.
- Note:** It may be advisable to make all cable connections before installing on VESA mount or stand, as appropriate.

Cable Connections

- ___ Make all rear jack panel connections, as appropriate.

Commercial Mode Setup

- ___ Complete appropriate procedures as described in this document for Commercial Mode operation.

Hardware Connections

- ___ Install any additional hardware as appropriate to your institution, LAN, etc.

Pass-through Mode

This mode allows you to configure individual TVs for Pro:Centric and/or FTG Mode via CPU operation. This mode also allows external control via either the GAME CONTROL/MPI port or the TLT (RS-232C) port on the TV rear jack panel.

There are several methods for configuring individual TVs that are currently in Pass-through Mode: using one of the First Use Wizard options or using the Custom Master TV Setup procedure.

First Use Wizard

When the TV is in a factory default state, the First Use Wizard provides three configuration options, including configuration of basic settings (language & location, network settings, etc.), configuration via the Solution Settings / EZ-Manager Wizard (automated or manual options for configuring essential items for Pro:Centric operation), and configuration via the IP Environment Menu (network settings, manual Pro:Centric settings, etc.). Use the Installer Remote to make selections and complete each step. See “First Use Wizard” on pages 16 to 17 for further information.

Custom Master TV Setup

The Custom Master TV Setup procedure enables you to create a customized Master TV Setup for Pass-through Mode or FTG Mode via CPU configuration purposes. Use the Installer Remote to configure Installer Menu items as required for TV operation and set up TV features (Channels, Picture, Sound, etc.). See “Custom Master TV Setup” on pages 46 to 48 for detailed information.

Installer Menu

To create a Master TV Setup, you will need to know how to access the commercial controller (PTC) Installer Menu and make changes to the default values as required. If necessary, familiarize yourself with the Installer Menu and how to make and save changes. See pages 35 to 45 for information on accessing the Installer Menu and for detailed descriptions of the Installer Menu items.

TV Setup Menus

On-screen setup menus control the features of the TV. Use the Installer Remote to access the TV setup menus, and set the TV features to the desired configuration for the end user.

Cloning

Cloning refers to the process of using a Master TV Setup to configure a Target TV. The Master TV's clonable setup menu features should be configured as part of the Master TV Setup. If there are features in the Master TV's setup—channel icons or labels, digital font options, etc.—that are not set or that are set incorrectly, those features also will not be set or will be set incorrectly in the Target TVs. See pages 49 to 54 for detailed information on Clone (.tlx) files and cloning requirements and procedures.

External Control

To control the TV using an external MPI control device, you must use the TV's GAME CONTROL/MPI port for communication purposes. In these TVs, Installer Menu item 118 POWER SAVINGS controls the power circuitry for both the embedded b-LAN module and the GAME CONTROL/MPI port; therefore, to ensure that the GAME CONTROL/MPI port circuitry is powered, thus enabling MPI communication, Installer Menu item 118 POWER SAVINGS must be set appropriately. See Installer Menu item descriptions as well as Reference section, "b-LAN Setup & Overview," for further information.

To control the TV using an external TLT control device, you must use the TV's RS-232C port for communication purposes. See Reference section, "TLT Communication Parameters," for further information.

FTG Mode

In this mode, an FTG Channel Map enables the decryption of each Pro:Idiom[®] encrypted channel. The FTG Channel Map also provides logical channel mapping of physical RF channels (digital and analog), and Aux inputs. The method for creating the FTG Channel Map is ultimately determined by which element of the TV will "own" the FTG Channel Map—the CPU or the EBL.

For these TV models, there are two FTG Modes—FTG Mode via CPU and FTG Mode via EBL—which are separate and distinct FTG Modes of operation, each with its own unique advantages and requirements, as outlined below.

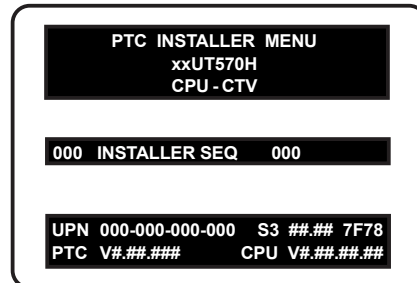

Typical Installer Menu

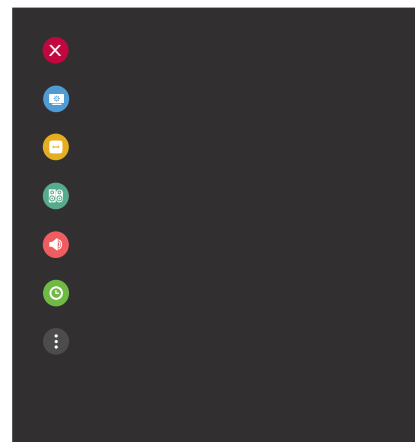

TV Setup Menus (Quick Settings)

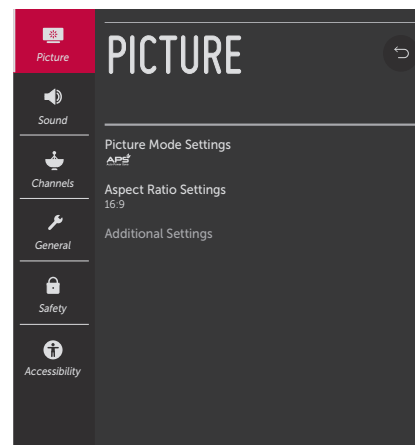

TV Setup Menus (Advanced Settings)

Commercial Mode Overview (Cont.)

When the TV CPU is configured with an FTG Channel Map, the CPU controls and restricts the tuning operation of the TV, and when the EBL is configured with an FTG Channel Map, the EBL controls and restricts the tuning operation of the TV. In these models, depending on the types of channels included in the FTG Channel Map, FTG Mode via CPU also provides the option to select either logical or physical tuning (see notes at the top of the following page) during configuration. You must determine which element of the TV will own the FTG Channel Map before you can begin configuration.

FTG Mode via CPU

This mode provides the following features:

- Logical or physical channel tuning of physical RF channels and Aux inputs.
- Mapping of RF channels with minor (program) numbers up to 999.
- FTG Channel Map of up to 600 channels.
- Start Channel set for RF or Aux input delivered content.
- Pro:Centric data delivery over RF or IP.
- TV Zoning (including channel restrictions by Zone) option for location-specific configurations.

LG's Cloud Configuration Tool enables you to create an FTG Configuration (.tlx) file, which may be used to configure the CPU for FTG Mode. You can also create a Clone (.tlx) file from a Master TV Setup that may be used to configure the CPU for FTG Mode.

Note: The TV Zoning feature is supported via ".tlx" file. See Reference section, "Using the TV Zoning Feature," for further information.

In this mode, the CPU is the owner of the FTG Channel Map and must be configured with an FTG Channel Map and FTG Installer Menu settings using one of the following processes:

- Local: Configure an individual UT570H/UT577H TV via its USB port using a USB memory device / ".tlx" file. The file may be either a Clone file (see "Cloning Procedures" on pages 49 to 54) or an FTG Configuration file (see "Cloud Configuration Tool Overview" on pages 55 to 60).
- Remote: Configure all UT570H/UT577H TVs at the site using a Pro:Centric server head end device (Example: PCS400R). Refer to the **Pro:Centric Server Admin Client User Guide** for further information.

FTG Mode via EBL

This mode provides the following features:

- Logical channel tuning of physical RF channels and Aux inputs.
- Mapping of RF channels with minor (program) numbers up to 255.
- FTG Channel Map of up to 141 logical channels.
- Start Channel set for RF or Aux input delivered content.
- Pro:Centric data delivery over RF.

LG's FTG Device Configuration Application PC software is required to configure the EBL. In this mode, the EBL is the owner of the FTG Channel Map and must be configured with an FTG Channel Map and FTG Installer Menu settings using one of the following processes:

Note: In order to create an FMA Configuration (.fma) file for these models that can be used for remote management of FTG Installer Menu settings, you will need to "Read" FTG Installer Menu settings from a Master TV. See Reference section, "FTG Mode via EBL (Local Configuration)," for further information.

- Local: Configure an individual UT570H/UT577H TV's EBL via its TV-LINK CFG jack using a direct PC-to-TV (EBL) connection and the FTG Device Configuration Application. See Reference section, "FTG Mode via EBL (Local Configuration)," for information on the "Write" process for an FTG Channel Map and FTG Installer Menu settings.
 - Remote: Configure all UT570H/UT577H TV EBLs at the site using a Free-To-Guest Management Appliance (FMA) head end device (Example: FMA-LG102). Refer to the **Free-To-Guest (FTG) Device Configuration Application User Guide** and/or the Installation & Configuration Guide for the FMA device for further information.
-

Note: Logical channel mapping of physical RF channels eliminates dash tuning; for example, physical 19-3 can be mapped to logical channel 9. It also allows physical RF channels and Aux inputs to be listed in any order, not only in physical numeric ascending order. Physical channel tuning requires that you include the dash when direct entering RF channel numbers and Aux inputs (the latter designated by 130-0 through 137-0).

While the TV is in FTG Mode:

- Users can still access the Installer Menu using an LG Installer Remote; however, all Installer Menu items will be read-only.
- FTG Mode via CPU configuration changes must be made using a “.tlx” file (typically edited in the Cloud Configuration Tool), while FTG Mode via EBL configuration changes must be made using the FTG Device Configuration Application. Channel Map and Installer Menu configuration utilities in both applications enable you to make changes, respectively, to the FTG Channel Map and FTG Installer Menu settings as necessary. Based on the initial method used to configure the TV for FTG Mode operation (via CPU or EBL), all subsequent changes must be transferred to either the TV CPU or the EBL via a process that is in accordance or compatible with that method (see information on local configuration in this document or refer to documentation for the head end device/server for information on remote management).
- If it becomes necessary to restore the TV to Pass-through Mode, there are several options that will enable you to do so. See Reference section, “Restoring Factory Defaults on the TV(s),” for further information.

Pages 55 to 60 provide overviews of the utilities that comprise the Cloud Configuration Tool. Refer to the **Cloud Configuration Tool User Guide** for further information on the Cloud Configuration Tool. Refer to the **Free-To-Guest (FTG) Device Configuration Application User Guide** for information on the FTG Device Configuration Application.

Remote Management in FTG Mode

When the TV is configured for FTG Mode via CPU, remote management of the FTG Channel Map and FTG Installer Menu settings is provided by a Pro:Centric server, via a Clone/Configuration (.tlx) file loaded on the Pro:Centric Admin Client. See the **Pro:Centric Server Admin Client User Guide** for further information.

When the TV is configured for FTG Mode via EBL, the *b*-LAN module, which is internal to the TV, allows hotel/institution head end equipment (for example, an FMA-LG102) with *b*-LAN technology to provide remote management of the FTG Channel Map and FTG Installer Menu settings. See Reference section, “*b*-LAN Setup & Overview,” for further information.

Application Tuning Mode / Pro:Centric Direct

In Application Tuning Mode, the TV’s Channel Map resides in an application, such as LG’s Pro:Centric Direct HTML application. With Pro:Centric Direct, the Channel Map is created in the Pro:Centric server’s Admin Client web editor, and the tuning operation of the TV is controlled and restricted based on this Pro:Centric Direct Channel Map.

Application Tuning Mode with the Pro:Centric Direct HTML application provides the following features:

- Decryption of each Pro:Idiom® encrypted channel.
- Logical channel tuning of physical RF channels (digital and analog).
- Mapping of RF channels with minor (program) numbers up to 999.
- Start Channel set for RF delivered content.

Commercial Mode Overview (Cont.)

- Pro:Centric data delivery over RF or IP.
- TV Zoning (Installer Menu items only) option for location-specific configurations.

You must use the Pro:Centric Direct Admin Client / Channel Map configuration utility to create the Pro:Centric Direct Channel Map, define channel attributes, and set the Start Channel. Refer to the **Pro:Centric Direct Admin Client User Guide** for further information.

Note: The TV Zoning feature is supported via “.tlx” file—typically a Clone (.tlx) file that has been created from a Master TV Setup. See Reference section, “Using the TV Zoning Feature,” for further information.

While the TV is in Application Tuning Mode:

- Users can still access the Installer Menu using an LG Installer Remote; however, all Installer Menu items will be read-only.
- While it is possible to update a TV’s Installer Menu and/or Setup Menu settings locally using a USB memory device / Clone (.tlx) file, any Pro:Centric Direct configuration changes are typically made remotely via the Pro:Centric server / Pro:Centric Direct Admin Client. The Admin Client’s Channel Map configuration utility enables you to create and edit the Pro:Centric Direct Channel Map, while the TV Configuration utility (in conjunction with a Clone [.tlx] file loaded on a server carousel) enables you to make changes to TV Installer Menu and/or Setup Menu settings.
- If it becomes necessary to restore the TV to Pass-through Mode, it is possible to do so. See Reference section, “Restoring Factory Defaults on the TV(s),” for further information.

Refer to the **Pro:Centric Direct Admin Client User Guide** for further information on configuration and management via the Pro:Centric Direct Admin Client.

Determining the TV Operating Mode

To determine the operating mode of the TV, press **MENU SETTINGS** on the Installer Remote. The menu displayed depends on the operating mode. See examples below.

If the Function Menu appears, the TV is in a mode (FTG, ATM, PPV, etc.) that does not allow the end user to change the fundamental TV setup. If the TV setup menus (Quick Settings) appear, the TV is in Pass-through Mode.



Function Menu
Indicates the TV is not in Pass-through Mode. While the TV is in this mode, Installer Menu settings can be accessed as read-only.

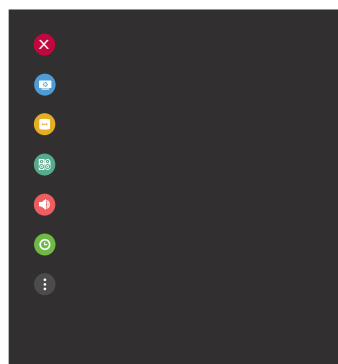

TV Setup Menus
Shows that the TV is in Pass-through Mode.

These TV models support LG's Pro:Centric Java application, as well as the Pro:Centric Direct HTML application. Only one application may be implemented at a time. The following sections provide an overview of the application features and functionality.

Interactive Menu Features

Both the Pro:Centric Java (GEM) application and the Pro:Centric Direct HTML application enable guests to locate and select television entertainment, check the daily weather, view hotel and surrounding amenities, etc. via custom portal interactive menus. The Pro:Centric Java application provides multiple templates for portal interactive menus, while the Pro:Centric Direct HTML application, in addition to providing multiple templates for portal interactive menus, also enables you to custom-create portal and application content.

Pro:Centric application features include:

- Portal and information screens/pages (including a "Welcome" page) that include branding logos.
- An optional customized user interface (custom "skins").
- Billboards and points-of-interest maps that can be customized to focus on hotel amenities, local attractions and businesses, restaurants, news, events, etc.
- An optional Weather billboard that includes a local radar map, current conditions, and a four day forecast.
- An interactive channel guide that provides a channel list with channel icons. An electronic program guide (EPG) is an optional feature that displays up to three days of programming information viewable by channel and time.
- Video spooling that enables the hotel to deliver a video file to guest TVs for promotion and information purposes.

In addition to the those indicated above, the Pro:Centric Direct HTML application also offers the following features:

- Optional messaging features, including notices, ticker text, and ad banners.
- Additional media support, specifically music accompaniment, for portal displays.
- An optional flight information display.

For each Pro:Centric application, an Admin Client web editor/content wizard is provided for customer configuration of portal content. The Pro:Centric Direct Admin Client features the Pro:Centric Direct Project Editor, which provides design tools (including templates) that enable customization of all portal pages. Please contact your LG service representative for further information.

Note: Customized content is typically defined by the service integrator and/or hotel administrators. LG does not provide hotel-specific content.

Interactive Menu Navigation

An LG Pro:Centric-capable TV remote control provides access to both interactive menus and regular TV features. Press **PORTAL** on the remote to access the interactive menus.

Interactive menu options may vary, depending on Pro:Centric features enabled for the site and/or customized content. The following examples show typical portal interactive menus.

Pro:Centric Operation (Cont.)

Example: Pro:Centric Java (GEM) Application Portal

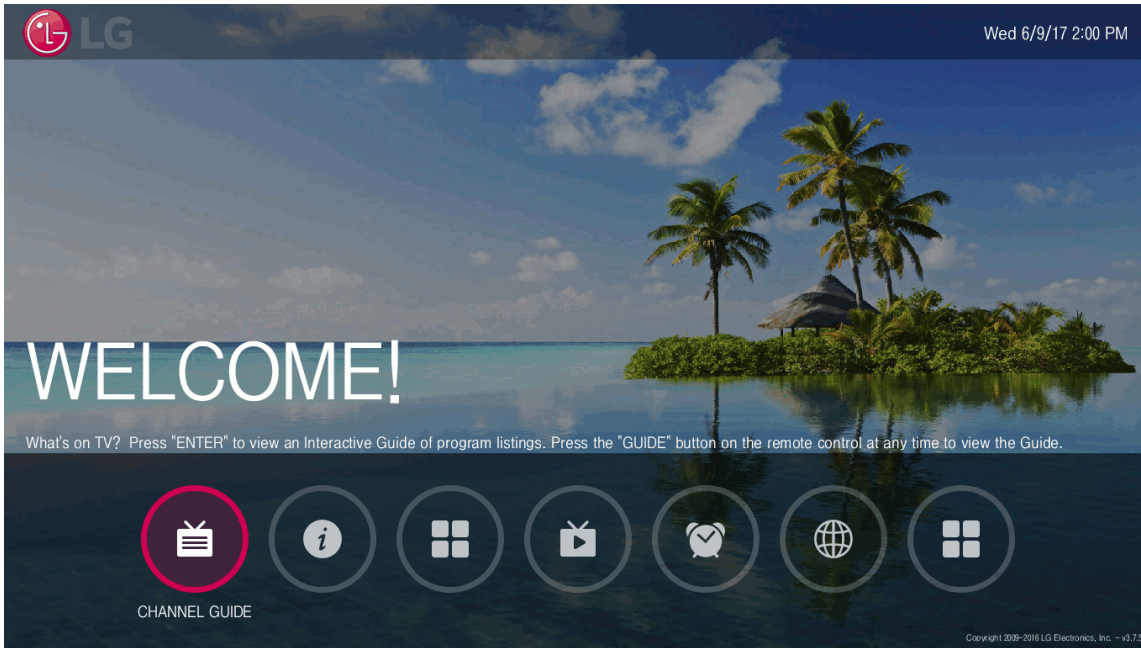

Example: Pro:Centric Direct HTML Application Portal

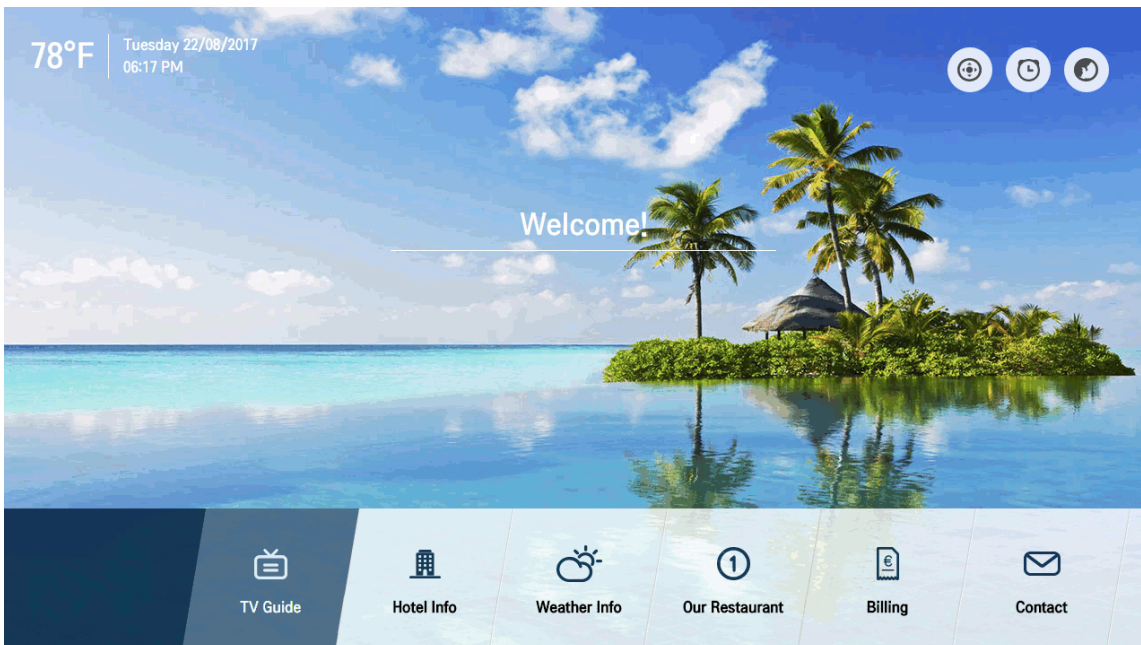

Pro:Centric Java Application Setup

The Pro:Centric Java (GEM) application operates in conjunction with FTG and PPV Modes. This section provides an overview of the setup required for the Pro:Centric features. Administration and management options for the Pro:Centric server are described in detail in the **Pro:Centric Server Admin Client User Guide**. This document describes only those settings that must be specified on the TVs to enable Pro:Centric remote management and/or the Pro:Centric Java application.

- Remote management (TV E-Z Installation): The Pro:Centric Admin Client provides remote management facilities for downloading boot logo image and software updates as well as facilities for downloading a Clone/Configuration (.tlx) file for FTG Mode via CPU configuration.
- Pro:Centric Java application: The application comprises the Pro:Centric interactive menus/features described on page 11. Pro:Centric application settings are managed via the Pro:Centric Admin Client for the Java application.

The Pro:Centric remote management facilities and application download are based on Installer Menu item settings that are used to set up the TV's Pro:Centric features. The Installer Menu / Pro:Centric server settings can be configured using one of the methods described below.

TV in Factory Default State

When the TV is in a factory default state, LG's First Use Wizard provides automated or manual options for configuring the TV's Pro:Centric server settings. See "First Use Wizard" on pages 16 to 17 for further information. The First Use / EZ-Manager Wizard (i.e., Solution Settings) also provides a USB configuration option that enables you to configure a TV for FTG Mode via CPU using a Clone/Configuration (.tlx) file stored on a USB memory device. The ".tlx" file incorporates FTG Installer Menu settings, including Installer Menu items 098 PRO:CENTRIC and 119 DATA CHANNEL, which are used to set up the TV's Pro:Centric features.

TV in Pass-through Mode

If the First Use Wizard has been exited and the TV is in Pass-through Mode, either:

- Set Installer Menu items 098 PRO:CENTRIC and 119 DATA CHANNEL to the appropriate values. See Installer Menu information on pages 35 to 45 for further details. Also, as necessary, refer to "Custom Master TV Setup" on pages 46 to 48 and/or cloning information on pages 49 to 54.
- Configure the appropriate Pro:Centric server settings in the IP Environment / Pro:Centric Menu. You must use this option, in particular, if you wish to configure IP settings for the Pro:Centric server. See "Accessing the IP Environment Menu" on page 61 and "Pro:Centric Setup" on pages 63 to 65 for further information.

Note: When the TV is in either Pass-through Mode or FTG Mode via CPU, you can also leave Installer Menu item 119 DATA CHANNEL set to its default value (255) to enable the TV's Data Channel Auto Search feature to set the DATA CHANNEL value. See item 119 description on page 44 for additional information.

TV in FTG Mode

If the TV is already in FTG Mode (via CPU or EBL), use the appropriate FTG application to update Installer Menu items #98 Pro:Centric and #119 Data Channel (along with their affiliated fields). Then, transfer the FTG Installer Menu settings to the TV in accordance with the FTG Mode of configuration. Refer to the FTG Mode overview on pages 7 to 9 for further information on FTG Mode operation and configuration. Also—for FTG Mode via CPU only—see note above regarding the option to use the TV's Data Channel Auto Search feature to set the DATA CHANNEL value.

Pro:Centric Operation (Cont.)

Pro:Centric Direct HTML Application Setup

The Pro:Centric Direct HTML application operates only in Application Tuning Mode (ATM). This section provides an overview of the setup required for the Pro:Centric Direct features. Administration and management options for the Pro:Centric server are described in detail in the **Pro:Centric Direct Admin Client User Guide**. This document describes only those settings that must be specified on the TVs to enable Pro:Centric remote management and/or the Pro:Centric Direct HTML application.

- Remote management (TV E-Z Installation): The Pro:Centric Direct Admin Client provides remote management facilities for downloading boot logo image and software updates as well as facilities for downloading Installer Menu configuration updates via Clone (.tlx) file to the TVs at the site/institution.
Note: The Pro:Centric Direct Channel Map is created and maintained in the Pro:Centric Direct Admin Client. Thus, any Clone file that is loaded on the server for remote configuration may only contain Installer Menu and/or Setup Menu profiles.
- Pro:Centric Direct HTML application: The application comprises the Pro:Centric interactive menus/features described on page 11. Pro:Centric Direct application settings are managed via the Pro:Centric Direct Admin Client.

The Pro:Centric remote management facilities and application download are based on Installer Menu item settings that are used to set up the TV's Pro:Centric features. The Installer Menu / Pro:Centric server settings can be configured using one of the methods described below.

TV in Factory Default State

When the TV is in a factory default state, LG's First Use Wizard provides automated or manual options for configuring the TV's Pro:Centric server settings. See "First Use Wizard" on pages 16 to 17 for further information. The First Use / EZ-Manager Wizard (i.e., Solution Settings) also provides a USB configuration option that enables you to configure the TV's Installer Menu settings using a Clone (.tlx) file stored on a USB memory device. Installer Menu items 098 PRO:CENTRIC and 119 DATA CHANNEL are used to set up the TV's Pro:Centric features.

TV in Pass-through Mode

If the First Use Wizard has been exited and the TV is in Pass-through Mode, either:

- Set Installer Menu items 098 PRO:CENTRIC and 119 DATA CHANNEL to the appropriate values. See Installer Menu information on pages 35 to 45 for further details. Also, as necessary, refer to "Custom Master TV Setup" on pages 46 to 48 and/or cloning information on pages 49 to 54.
- Configure the appropriate Pro:Centric server settings in the IP Environment / Pro:Centric Menu. You must use this option, in particular, if you wish to configure IP settings for the Pro:Centric server. See "Accessing the IP Environment Menu" on page 61 and "Pro:Centric Setup" on pages 63 to 65 for further information.

Note: When the TV is in either Pass-through Mode or Application Tuning Mode, you can also leave Installer Menu item 119 DATA CHANNEL set to its default value (255) to enable the TV's Data Channel Auto Search feature to set the DATA CHANNEL value. See item 119 description on page 44 for additional information.

TV in Application Tuning Mode

If the TV is already in Application Tuning Mode, use a Master TV of the same model to create and export a Clone (.tlx) file with the desired settings for Installer Menu items 098 PRO:CENTRIC and 119 DATA CHANNEL. Then, transfer (import) the Clone file to the Target TV. Refer to the Application Tuning Mode / Pro:Centric Direct overview on pages 9 to 10 for further information on Pro:Centric Direct operation and configuration. To transfer the Clone file remotely, use the appropriate utilities in the Pro:Centric Direct Admin Client to upload the Clone file to the Pro:Centric server and set up its distribution to the Target TV(s) at the site. See also note above regarding the option to use the TV's Data Channel Auto Search feature to set the DATA CHANNEL value.

First Use Wizard

Note: After it is turned ON, the TV begins an initialization process, and it may take several minutes for the First Use Wizard to appear.

LG's First Use Wizard, comprising multiple configuration options, will appear on the screen each time the TV is turned ON, until one of its configuration methods has been completed or the wizard is exited. Use the Installer Remote to make selections and complete each step.

- **Basic Settings:** Initiates the Basic Settings Wizard, which enables you to select basic TV settings, including the TV's language and location, and run Channel Tuning. It also allows you to configure the TV's network settings, if desired. See "Basic Settings Wizard" on pages 18 to 20 for further information.
- **Solution Settings (default):** Initiates the EZ-Manager Wizard. The primary purpose of the EZ-Manager Wizard is to guide you through the process (automated or manual) of configuring the essential Installer Menu items for Pro:Centric operation.

While the EZ-Manager Wizard is intended primarily for Pro:Centric-related configuration, the wizard also offers Zoning and network configuration options and, in addition, enables you to access the TV Manager / USB download options as part of the configuration process, if desired, to perform USB configuration and/or update functions. See "Solution Settings / EZ-Manager Wizard" on pages 21 to 30 for further information.

- **IP Environment Settings:** Enables you to access the IP Environment Menu to set up network features of the TV, including Pro:Centric features. See "IP Environment Setup" on pages 61 to 65 for further information.



Caution: Do NOT unplug the TV power cord or remove the antenna cable or, if applicable, the LAN cable during the configuration process, as doing so will interrupt the current step and may corrupt the configuration data.

Before You Begin

- If you plan to create a customized Master TV Setup using the procedure described on pages 46 to 48, be sure to exit the LG First Use Wizard in order to avoid setup conflicts or setting modes that may cause unintended behavior or restrict the custom setup procedure. See also "Initiate Configuration or Exit the First Use Wizard" below.
- If it has been completed or exited and therefore does not display, the First Use Wizard can be reactivated; however, this requires that you restore the TV to a factory default condition. See Reference section, "Restoring Factory Defaults on the TV(s)," for further information.

Initiate Configuration or Exit the First Use Wizard

The Welcome screen provides a brief introduction to the First Use Wizard.

Note: The Welcome screen is allotted a time frame of 10 seconds, after which the Solution Settings / EZ-Manager Wizard proceeds automatically. If a Pro:Centric server is configured on the system/network and if no location-specific settings are required in the TV, for example, TV Zone, Label, and/or Room Number settings, from this point, the EZ-Manager Wizard can proceed through each of the configuration steps with no further user interaction.

(Continued on next page)

(Continued from previous page)

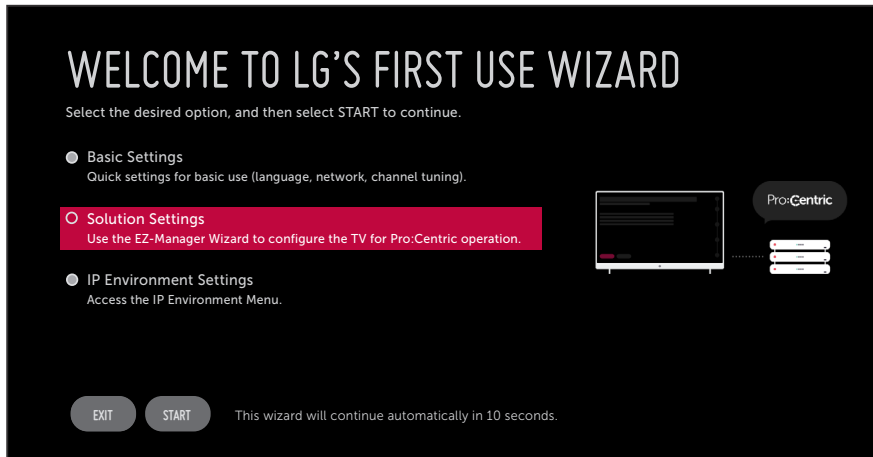

Use the arrow keys on the Installer Remote to select the desired option in the Welcome screen:

- To proceed with the Basic Settings Wizard, select/highlight **Basic Settings**, and then press **OK**. Then, select **START** and press **OK** to continue. See “Basic Settings Wizard” on pages 18 to 20 for further information.
- To proceed with the EZ-Manager Wizard, select/highlight **Solution Settings**, and then press **OK**. Then, select **START** and press **OK** to continue. See “Solution Settings / EZ-Manager Wizard” on pages 21 to 30 for further information.
- To access the IP Environment Menu, select/highlight **IP Environment Settings**, and then press **OK**. Then, select **START** and press **OK** to continue. See “IP Environment Setup” on pages 61 to 65 for further information.
- To exit the First Use Wizard, select/highlight the **EXIT** button at the bottom of the screen, and then press **OK**. In the exit confirmation screen, select **EXIT**, and then press **OK** once more on the Installer Remote.

Note: If you exit the First Use Wizard from the Welcome screen, no configuration will be performed and all Installer Menu items will retain their default values, including Installer Menu item 119 DATA CHANNEL. The default DATA CHANNEL setting (255) means that the Pro:Centric remote management feature on this TV will be activated if a Pro:Centric server is installed and the Data Channel value is set during a Data Channel Auto Search (see item 119 description on page 44 for additional information). If you actually would like to disable the Pro:Centric feature, both the EZ-Manager Wizard and the IP Environment Menu provide an option to do so, and/or you may disable Pro:Centric by modifying the value of Installer Menu item 119.

Basic Settings Wizard

This section describes the configuration options available when you select “Basic Settings” from the First Use Wizard / Welcome screen. You can select the “BACK” button, where available, to check previous settings, as necessary.

Note: Each Basic Settings Wizard step is allotted a 10-second time frame after which the wizard proceeds automatically. If default settings are appropriate, the wizard can proceed through each of the configuration steps with no further user interaction. If you turn OFF the TV while the wizard is in progress, when you turn the TV back ON, the First Use Wizard / Welcome screen will be displayed. You will then have the opportunity to (re)initiate the desired configuration process.

Note: To exit the wizard at any time, use the arrow keys on the Installer Remote to select/highlight the **X** button at the top right of the screen, and then press **OK**. In the exit confirmation screen, select **EXIT**, and then press **OK** once more on the Installer Remote.

1. In the Language & Location screen, use the arrow keys on the Installer Remote to select/highlight each appropriate field in turn—Language or Time Zone—and then press **OK**. Then, use the up/down arrow keys to select the applicable value from the drop-down list of options for the selected field. When you are ready to continue, use the arrow keys on the Installer Remote to select **NEXT**, and then press **OK**.

Note: The Country field is inaccessible/grayed out because these models are only available in the US. Also, if you allow the wizard to progress without specifying data in this screen, the time zone will be set for “New York” (Eastern Standard Time).

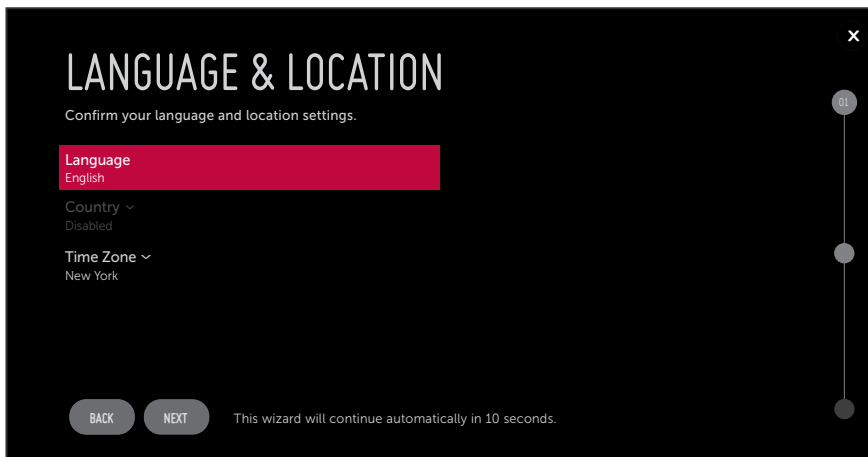

2. The next screen enables you to configure the network settings of the TV. Refer to the steps below to configure a wired connection between the TV and the network. When you are ready to continue, use the arrow keys on the Installer Remote to select **NEXT**, and then press **OK**.

Note: If an Ethernet cable is not currently connected between the TV and the network and you do not want to configure/complete configuration of network settings at this time, you can select/highlight **SKIP**, and press **OK** on the Installer Remote to continue to the next step.

- a. If not already done, connect the appropriate cable between the TV and the network.

(Continued on next page)

(Continued from previous page)

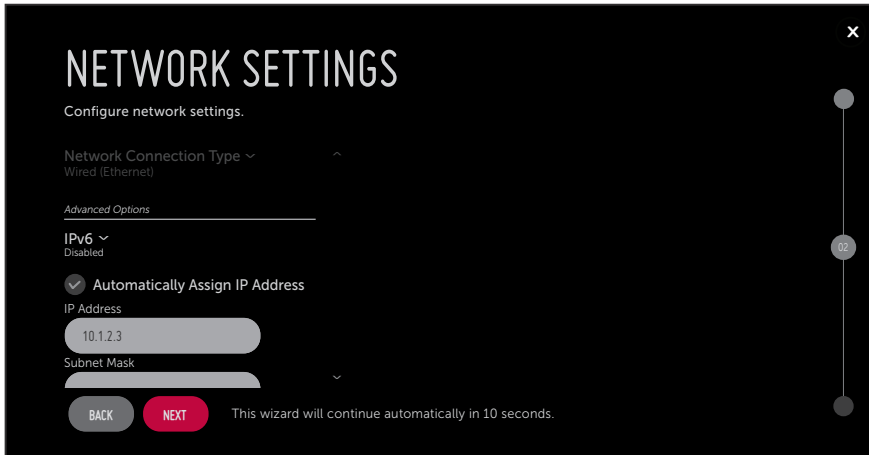

- b. If not already done/detected, select **Wired (Ethernet)** in the Network Connection Type field, and then press **OK** on the Installer Remote.
- c. By default, the TV uses DHCP, and if a LAN is detected, the TV will request an IP address from the DHCP server on the network. If the TV is able to connect to the network, the network configuration data will be displayed on the screen as shown in the example above.

If the network is not configured for DHCP, or if you want to enable/disable IPv6 or specify static IP configuration data, continue with steps (d) and/or (e), respectively.

- d. (Optional) To enable IPv6, select/highlight the IPv6 field and press **OK**. Then, select **Enabled** from the drop-down list of options.
- e. (Optional) If required, you can edit the IP data for this TV as follows:
 - De-select the “Automatically Assign IP Address” checkbox under “Advanced Options.”
 - For each data entry field: Use the arrow keys on the Installer Remote to select the field and press **OK**. You can use the number keys on the Installer Remote to direct enter numeric values or use the arrow keys to select the appropriate alphanumeric characters (as applicable) from the pop-up virtual keyboard displayed at the bottom of the screen. When you are done, select **Enter** from the virtual keyboard, and then press **OK** on the Installer Remote.

Note: For IPv4, you must use the dot “.” key from the virtual keyboard to separate each octet of an IP address. For IPv6, you must use the colon “:” key from the virtual keyboard to separate each group of an IP address.

3. The Channel Tuning screen is the final step of the Basic Settings Wizard.
 - If you would like to initiate an automated channel scan (i.e., a search for all available digital and analog channels), use the arrow keys on the Installer Remote to select the RF tuning band field, and select the appropriate option. Then, press **OK**. Next, select the **CHANNEL TUNING** button at the bottom of the screen, and press **OK**.

(Continued on next page)

Basic Settings Wizard (Cont.)

(Continued from previous page)

Tuning progress will be shown in a new Channel Tuning screen. The scan typically takes a few minutes. When the channel scan is complete, the TV will launch the IP Environment Menu. See additional information below.

- If you would like to continue with the TV setup without running Channel Tuning, select the **DONE** button at the bottom of the screen, and press **OK**. The TV will launch the IP Environment Menu. See additional information below.

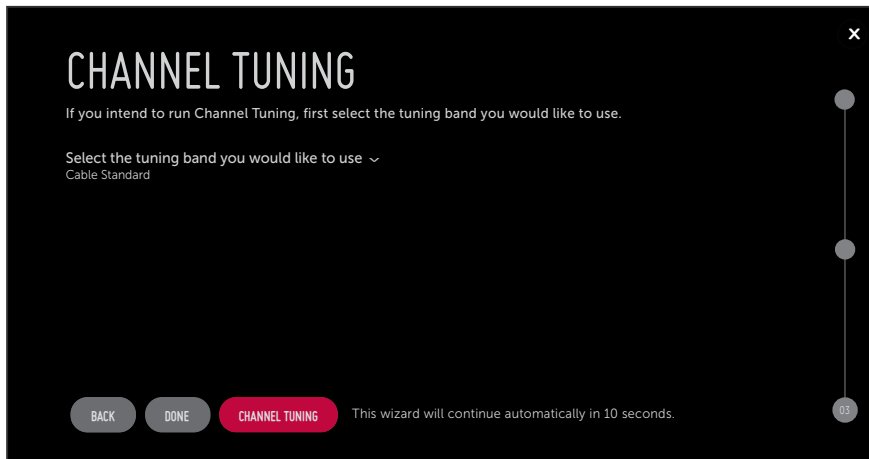

As indicated above, the IP Environment Menu is always launched after the Basic Settings Wizard is complete (and once Channel Tuning is finished, if applicable). The IP Environment Menu launches with the Network Menu options on display (default IP Environment Menu launch scenario). See "IP Environment Setup" on pages 61 to 65 for further information on the options available in the IP Environment Menu.

This section describes the EZ-Manager Wizard that is initiated when you select “Solution Settings” from the First Use Wizard / Welcome screen.

Note: If the Pro:Centric server is configured on the system/network and if no location-specific settings are required in the TV, for example, TV Zone, Label, and/or Room Number settings, you can simply turn ON the TV, and once initiated, the wizard will proceed through each of the configuration steps with no further user interaction.

Note: Select the “BACK” button, where available, to check previous settings, as necessary. Also note that if you turn OFF the TV while the wizard is in progress, when you turn the TV back ON, a “Diagnostics” screen will be displayed (see also note below).

Note: If any of the configuration steps fails, you will see a “Diagnostics” screen with an indication of the failure. You will then have the opportunity to reinitiate the configuration process from the previous screen or exit the EZ-Manager Wizard.

TV Configuration Options

In the TV Configuration Options screen, you can choose how to proceed with the configuration of this TV.



Note: If you intend to use the Zoning feature on the TV for location-specific configuration purposes, select the **ZONE & ROOM NUMBER** option from this screen and set the appropriate TV Zone # in the TV BEFORE you continue with additional configuration.

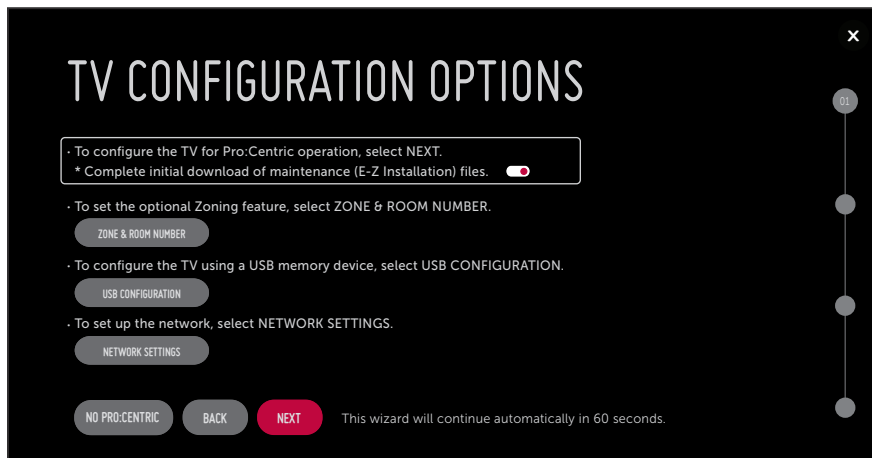

Note: If there is no user action in this screen within one minute, the wizard will automatically continue to the next configuration step. If you would like to exit the wizard at any time, use the arrow keys on the Installer Remote to select/highlight the **x** button at the top right of the screen, and then press **OK**. In the exit confirmation screen, select the appropriate “EXIT” option (see also note below), and then press **OK** once more on the Installer Remote.

Note: If you choose to exit the EZ-Manager Wizard from this point on, you will have the option to save any settings made by selecting **SAVE & EXIT** in the exit confirmation screen. Or, you can exit the wizard without saving any settings by simply selecting **EXIT** in the confirmation screen.

(Continued on next page)

Solution Settings / EZ-Manager Wizard (Cont.)

(Continued from previous page)

Use the Up/Down arrow keys on the Installer Remote to navigate between options on this screen.

- If you do not intend to install a Pro:Centric server on this system and you do not wish to use the wizard's Zoning, network settings, or USB configuration options, exit the wizard as follows: Select **NO PRO:CENTRIC**, and then press **OK**. This will disable the Pro:Centric feature of this TV (i.e., Installer Menu item 119 DATA CHANNEL will be set to 0) and exit the wizard. In the exit confirmation screen, select **EXIT**, and then press **OK** once more on the Installer Remote.

- To continue with Pro:Centric configuration, select **NEXT** (default) and press **OK** on the Installer Remote. See "Configure Pro:Centric Settings" on pages 24 to 29 for additional information.

Note: By default, any applicable maintenance (E-Z Installation) files are downloaded as part of the TV configuration. If you would like to skip the initial maintenance file download, select the (Yes) toggle button on the screen and press **OK** to change the value to (No). Maintenance files will still be downloaded during the daily update event, per Installer Menu item 121 setting.

- To set the Zoning feature on the TV, select **ZONE & ROOM NUMBER**. See "Zone and Room Number Assignments" below for further information.
- To configure the network settings of the TV, select **NETWORK SETTINGS**. See "Network Settings" on pages 23 to 24 for further information.
- To access the TV Manager / USB download options, select **USB CONFIGURATION**. See "USB Configuration" on pages 29 to 30 for further information.

Zone and Room Number Assignments

You may complete one or more of the fields in the Zone, Label, and Room Number screen or leave them at their default settings (TV Zone) or blank (Label and Room Number), as desired. However, if you intend to use the Zoning feature on this TV, you **MUST** specify the appropriate values in the TV Zone field as described below. See Reference section, "Using the TV Zoning Feature," for further information.

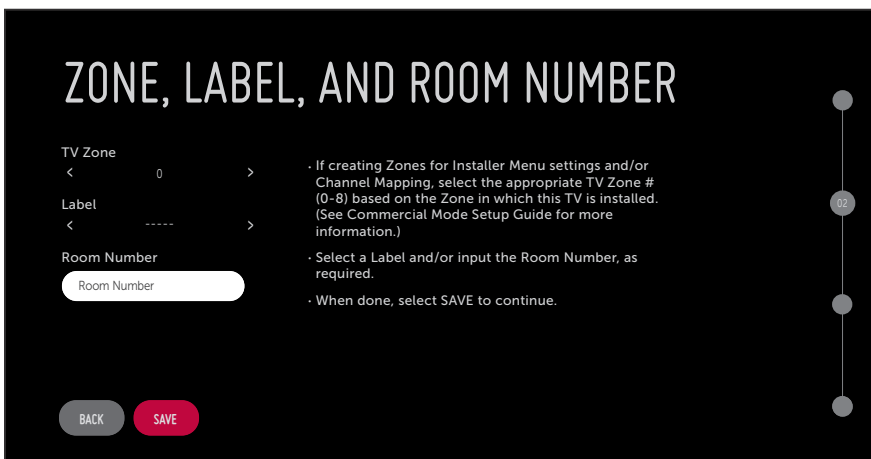

(Continued on next page)

Solution Settings / EZ-Manager Wizard (Cont.)

(Continued from previous page)

Note: The Zoning feature is only applicable for TVs that will be configured using a “.tlx” file (local or remote configuration).

1. Complete the appropriate field(s) as described below. Use the Up/Down arrow keys on the Installer Remote to navigate between each of the fields.
 - **TV Zone:** Enables you to set a TV Zone # so that the TV can be configured with Installer Menu and/or Setup Menu settings intended only for the assigned Zone. The Installer Menu and/or Setup Menu settings may be provided in a Clone/Configuration (.tlx) file. If the TV is being configured for FTG Mode via CPU, the TV Zone # setting also allows the TV to omit channels that have been restricted in the FTG Channel Map.

To change the TV Zone from its default value (0), navigate to the TV Zone field, and use the Left/Right arrow keys to specify the desired TV Zone # (1–8).
 - **Label:** Allows you to select a North, South, East, or West text label for this TV. In the Label field, use the Left/Right arrow keys to select the applicable label.
 - **Room Number:** Allows you to specify the number of the room—up to 16 characters—in which the TV is located. To enter a room number, navigate to the Room Number field and press **OK**. You can then use the number keys on the Installer Remote to direct enter a room number, or you can use the arrow keys to select the appropriate alphanumeric character(s) from the pop-up virtual keyboard at the bottom of the screen. When you are done, select **Enter** from the virtual keyboard, and then press **OK** on the Installer Remote.
2. When you are ready to continue, use the arrow keys to select **SAVE**, and then press **OK** on the Installer Remote to return to the TV Configuration Options screen. Then, proceed as required from the TV Configuration Options screen.

Network Settings

You may configure the wired connection between the TV and the network, as described below.

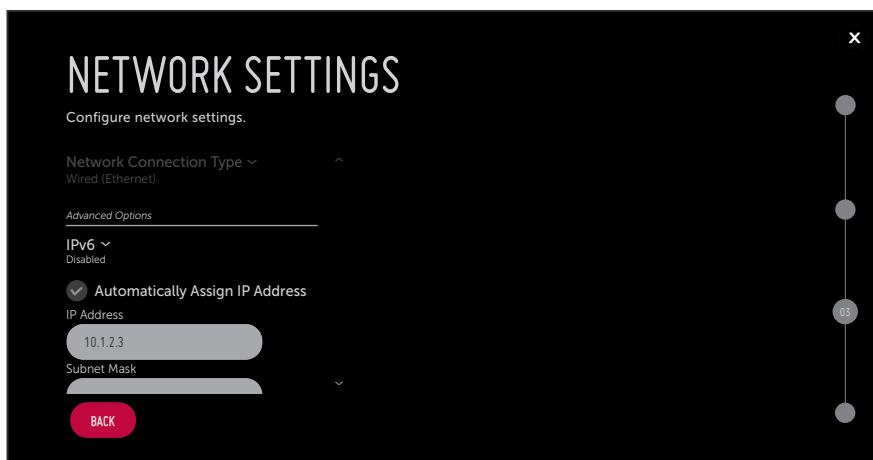

1. If not already done, connect the appropriate cable between the TV and the network.

(Continued on next page)

Solution Settings / EZ-Manager Wizard (Cont.)

(Continued from previous page)

2. If not already done/detected, select the **Wired (Ethernet)** option in the Network Connection Type field, and then press **OK** on the Installer Remote.
3. By default, the TV uses DHCP, and if a LAN is detected, the TV will request an IP address from the DHCP server on the network. If the TV is able to connect to the network, the network configuration data will be displayed on the screen as shown in the example above.

If the network is not configured for DHCP, or if you want to enable/disable IPv6 or specify static IP configuration data, continue with steps 4 and/or 5, respectively.
4. (Optional) To enable IPv6, select/highlight the IPv6 field and press **OK**. Then, select **Enabled** from the drop-down list of options.
5. (Optional) If required, you can edit the IP data for this TV as follows:
 - De-select the “Automatically Assign IP Address” checkbox under “Advanced Options.”
 - For each data entry field: Use the arrow keys on the Installer Remote to select the field and press **OK**. You can use the number keys on the Installer Remote to direct enter numeric values or use the arrow keys to select the appropriate alphanumeric characters (as applicable) from the pop-up virtual keyboard displayed at the bottom of the screen. When you are done, select **Enter** from the virtual keyboard, and then press **OK** on the Installer Remote.

Note: For IPv4, you must use the dot “.” key from the virtual keyboard to separate each octet of an IP address. For IPv6, you must use the colon “:” key from the virtual keyboard to separate each group of an IP address.
6. When you are ready to continue, use the arrow keys to select **BACK**, and then press **OK** on the Installer Remote to return to the TV Configuration Options screen. Then, proceed as required from the TV Configuration Options screen.

Configure Pro:Centric Settings

Once you select “NEXT” from the TV Configuration Options screen, the Searching for Pro:Centric Server screen is displayed, and you have the following options:

- You can allow the EZ-Manager Wizard to proceed with a series of automated steps to configure the TV for Pro:Centric operation and then to look for the Pro:Centric application and maintenance (E-Z Installation) files to download. In this case, the wizard uses a search algorithm to determine the Data Channel and the Pro:Centric Application Mode to set in the TV.

Continue with the “Automated Pro:Centric Configuration” subsection below.

- If you already know the settings (e.g., Data Channel and Pro:Centric Application Mode) that need to be configured in order for the TV to connect to the Pro:Centric server and/or if the Pro:Centric server is not yet installed, you may expedite the setup process by entering this data manually.

Continue with the “Manual Pro:Centric Configuration” subsection on page 26.

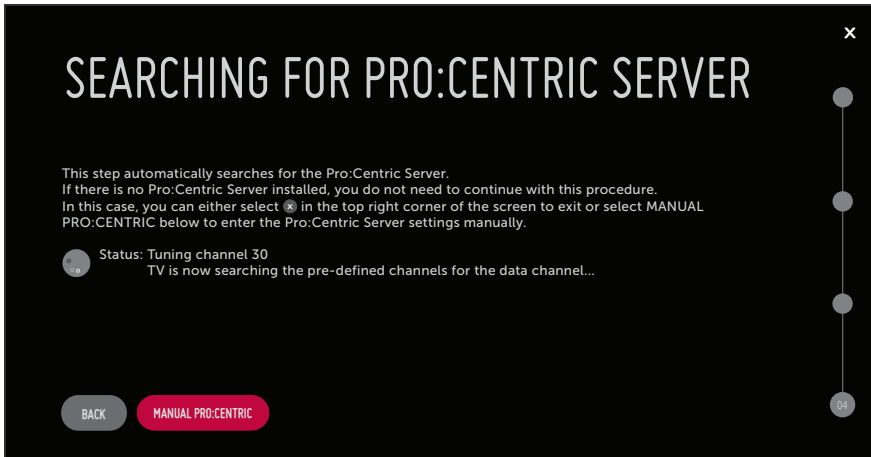

Automated Pro:Centric Configuration

Note: If the server is not yet configured on the system or if Pro:Centric data delivery will be over IP and there is no Domain Name System (DNS) server, use the manual configuration option to configure the TV's Pro:Centric server settings (see "Manual Pro:Centric Configuration" subsection on page 26). See also note below regarding DNS requirements.

Note: If there is a DNS server at the site, you can create a "procentric.local" DNS entry with the Pro:Centric server's IP address. Also, the Pro:Centric server's port number must be set to "80" to allow the automated Pro:Centric IP configuration via the EZ-Manager to find the server.

Once the Pro:Centric data channel is found (a Pro:Centric Server Was Found screen will be displayed) and the Pro:Centric Application Mode is determined, the wizard will advance to the Processing the Pro:Centric Configuration screen, which shows the progress of the data downloads (see example below). Note that some steps may require a few minutes.

If the process is successful, no further user interaction is required, though, in some instances, where the option (for example, "NEXT") is available, you may manually move forward to subsequent steps within the wizard to speed up the process.

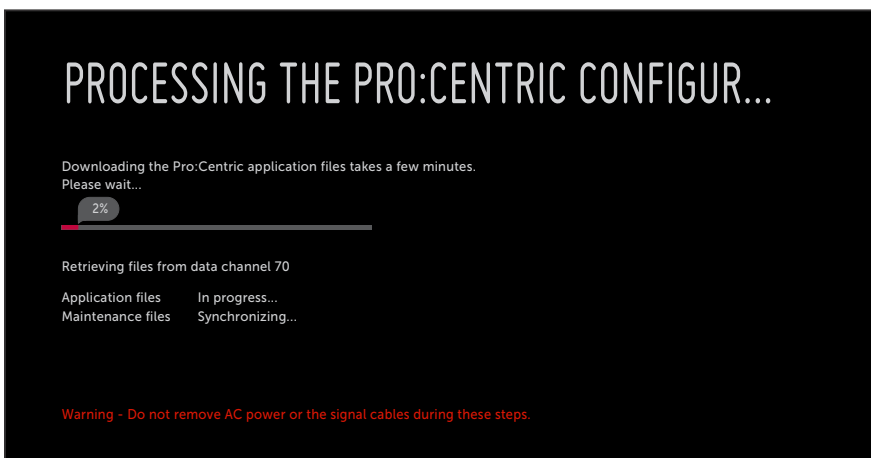

(Continued on next page)

Solution Settings / EZ-Manager Wizard (Cont.)

(Continued from previous page)

Note: If, after completing the search, the TV is unable to find the Pro:Centric data channel (while the Searching for Pro:Centric Server screen is on display), the wizard will stop and show a Diagnostics screen that enables you to manually return to the previous screen (to reinitiate the configuration) or exit the wizard.

When the Pro:Centric Configuration is complete, an EZ-Manager Configuration Complete screen is displayed (see example below), and after 10 seconds, the wizard exits, and the TV turns OFF.

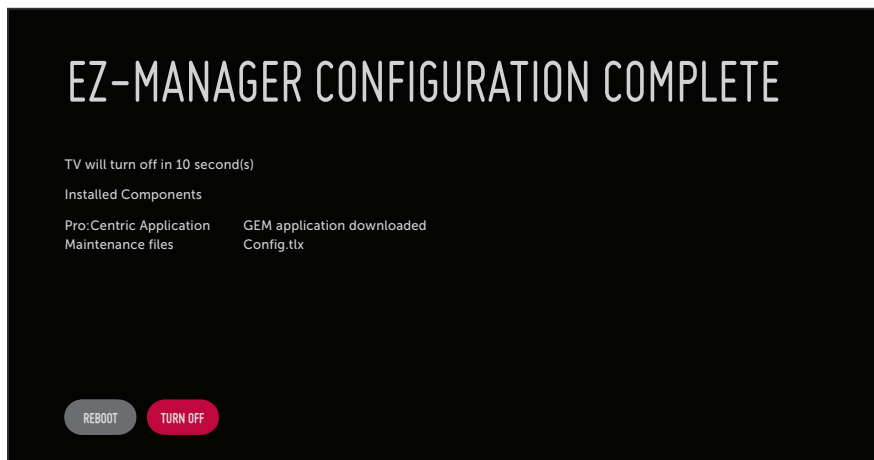

Note: With the EZ-Manager Configuration Complete screen on display, you can also manually turn off or reboot the TV. If desired, select **TURN OFF** or **REBOOT**, respectively, and then press **OK** on the Installer Remote.

Manual Pro:Centric Configuration

1. With the Searching for Pro:Centric Server screen on display, use the Left/Right arrow keys on the Installer Remote to select **MANUAL PRO:CENTRIC** at the bottom of the screen, and then press **OK**.

In the Pro:Centric Manual Configuration screen (see examples below), you will be able to configure the appropriate Pro:Centric settings in the TV. Use the Up/Down arrow keys on the Installer Remote to navigate between fields.

2. In the Pro:Centric Mode field, use the Left/Right arrow keys to select the appropriate Pro:Centric Application Mode—**GEM** (Java), **HTML**, or **CONFIGURATION ONLY**.

Note: For remote management only, select **CONFIGURATION ONLY**. The TV will search for TV E-Z Installation data downloads; however, Pro:Centric application data will not be downloaded, i.e., Installer Menu item 098 PRO:CENTRIC will be set to 0.

3. Refer to the appropriate subsection below, depending on the Pro:Centric server configuration, to complete the remaining fields.

(Continued on next page)

(Continued from previous page)

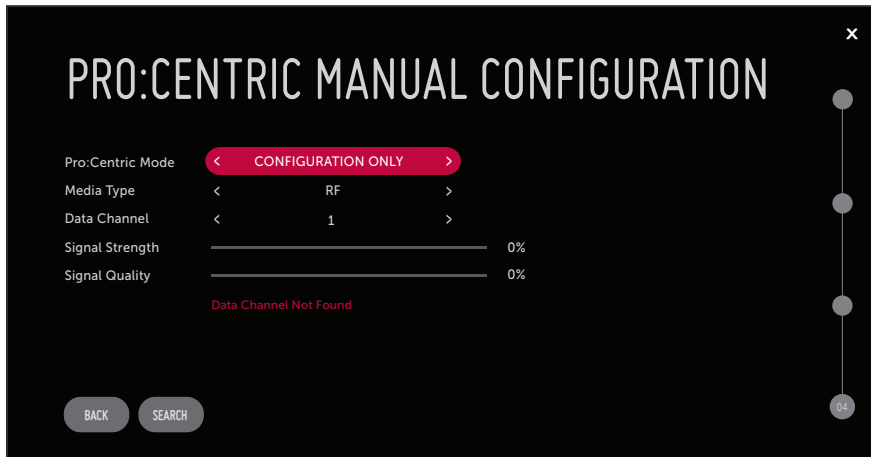

Pro:Centric Manual Configuration Screen with RF Media Fields

Note: By default, the Pro:Centric Manual Configuration screen initially shows RF configuration fields.

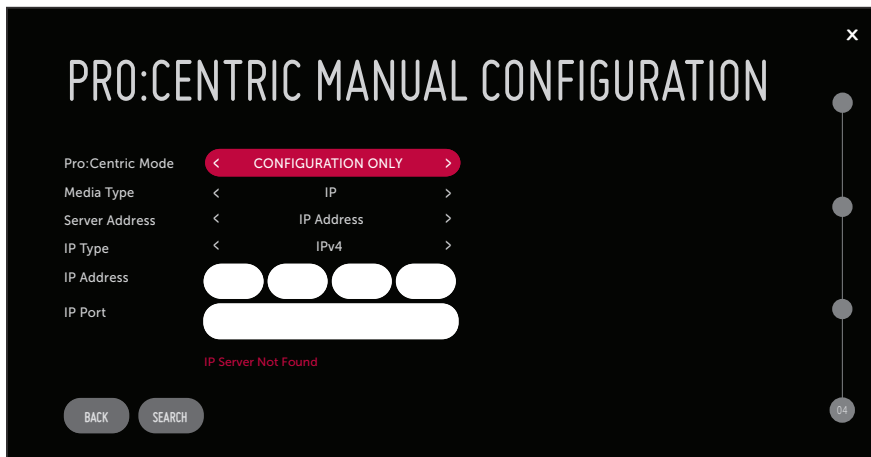

Pro:Centric Manual Configuration Screen with IP Media Fields

RF Configuration

- In the Media Type field, use the Left/Right arrow keys to select **RF**.
- In the Data Channel field, use the Left/Right arrow keys to select the RF channel number that will be used by the Pro:Centric server as its data channel. The Data Channel value can be set from 1 to 135.*

(Continued on next page)

* PCS150R and later Pro:Centric servers do not support HRC or IRC cable channel frequencies.

Solution Settings / EZ-Manager Wizard (Cont.)

(Continued from previous page)

IP Configuration

- a) In the Media Type field, use the Left/Right arrow keys to select **IP**.

Note: When you select “IP” as the Media Type, the default RF Data Channel and Signal Strength/Quality fields are replaced with Server Address, IP Type, IP Address, and IP Port fields.

- b) The Server Address field provides the option to specify the domain name of the Pro:Centric server instead of the server’s IP address. Use the Left/Right arrow keys to select the desired option—IP Address or Domain Name—for defining the server.

- c) Depending on your selection in the previous step, either:

- Select the appropriate IP type (either IPv4 or IPv6) in the IP Type field, and then enter the Pro:Centric server IP address in the IP Address field. The IP address must match the IPv4 or IPv6 (as applicable) address that is set in the Pro:Centric server.
- Enter the Pro:Centric server domain name in the Domain Name field. Note that in order for the domain name to be resolved to an IP address, there must be a DNS entry for the domain name.

For each data entry field: Use the arrow keys to select the field and press **OK**. Then, you can either use the number keys on the Installer Remote to direct enter data values, or you can use the arrow keys to select the appropriate number(s)/alphanumeric character(s) from the pop-up virtual keyboard displayed at the bottom of the screen. When you are done, select **Enter** from the virtual keyboard, and then press **OK** on the Installer Remote.

Note: For an IPv6 IP address, you must use the colon “:” key from the virtual keyboard to separate each group.

- d) Enter the Pro:Centric server port number in the IP Port field. The port number must match the port number that is set in the Pro:Centric server.

4. Once all fields are completed as required, you have two options:

- To save the data entered and exit the wizard, use the arrow keys to select the **ⓧ** button at the top right of the screen, and then press **OK**. In the subsequent pop-up confirmation window, select **SAVE & EXIT**, and then press **OK** once more. The Pro:Centric application and/or E-Z Installation data will be downloaded to the TV at a later time. This option is useful, in particular, if the Pro:Centric server has not yet been configured.
- To initiate a real-time download of Pro:Centric application and/or E-Z Installation data, use the arrow keys to select **SEARCH** and press **OK** to verify the configuration data provided in step 3. When the data is verified, the “SEARCH” button becomes a “NEXT” button. Select **NEXT** and press **OK** to continue (see also note below).

Note: With RF configuration, Pro:Centric server data must be present on the RF channel selected as the TV’s Data Channel in order for you to select “NEXT” (you will see a “Data Channel Found” message below the Signal Quality indicator). With IP configuration, Pro:Centric server data must be present via the wired LAN cable connection in order for you to select “NEXT” (you will see a “IP Server Found” message below the IP Port field).

(Continued on next page)

(Continued from previous page)

If you opt to initiate a real-time download in the last step, the EZ-Manager Wizard will proceed with the Pro:Centric application and/or E-Z Installation data downloads (see Processing the Pro:Centric Configuration screen example on page 25). When the Pro:Centric configuration is complete, an EZ-Manager Configuration Complete screen (see example on page 26) is displayed, and after 10 seconds, the wizard exits, and the TV turns OFF.

Note: With the EZ-Manager Configuration Complete screen on display, you can also manually turn off or reboot the TV. If desired, select **TURN OFF** or **REBOOT**, respectively, and then press **OK** on the Installer Remote.

USB Configuration

TV Manager / USB download options enable you to download configuration, boot logo (splash screen) image, or software files individually from a USB memory device to the TV. You can also use the Ez Download utility available from the menu to select multiple types of files to be downloaded at one time using one process.

Each of the USB download functions requires that you have the appropriate file(s) loaded on a USB memory device. If you wish to perform a software update or download a boot logo image file, the software/image file(s) must be stored in a folder named "LG_DTV" in the root directory of the USB memory device. Clone/Configuration (.tlx) files should simply be stored in the root directory of the USB device.

The procedure below assumes the desired file(s) is/are already loaded onto the USB device. For further information on the TV Manager / USB download options and file requirements, and/or for information on creating Clone/Configuration (.tlx) files, refer to the appropriate section(s) in this document.

Before You Begin

- If you intend to use the Zoning feature on this TV, make sure to set the appropriate TV Zone # in the EZ-Manager's Zone, Label, and Room Number screen BEFORE continuing with USB Configuration. See "TV Configuration Options" on page 21 for further information.
- Ensure the USB device to be used has been formatted with FAT format.
- When creating files to be downloaded, avoid using special characters (?, &, @, etc.) in filenames.
- Refer to "Ez Download Utility" on pages 31 to 34 for further information on the Ez Download utility.
- Refer to "Custom Master TV Setup" on pages 46 to 48 for information on creating a Clone (.tlx) file, and/or refer to "Creating an FTG Configuration File" on pages 55 to 57 for information on creating an FTG Configuration (.tlx) file for FTG Mode via CPU configuration.
- See Reference section, "Downloading a Boot Logo Image using a USB Memory Device," for boot logo image guidelines.
- See Reference section, "Updating TV/PTC Software using a USB Memory Device," for further information on software updates.

Solution Settings / EZ-Manager Wizard (Cont.)

USB Configuration via EZ-Manager Wizard

With either the TV Configuration Options or the Zone, Label, and Room Number screen on display, proceed as follows to configure the TV using the USB memory device.

1. Insert the USB memory device with the appropriate file(s) into the TV's USB port.
2. Use the arrow keys on the Installer Remote to select **USB CONFIGURATION**, and then press **OK**.

You will be redirected to the TV Manager / USB download options.

Note: You can select the **X** button at the top right corner of the screen and press **OK** on the Installer Remote at any time to return to the EZ-Manager Wizard.

Note: Ez Download is always selected by default when you initially access the TV Manager. Also note that Diagnostics is for service use only.

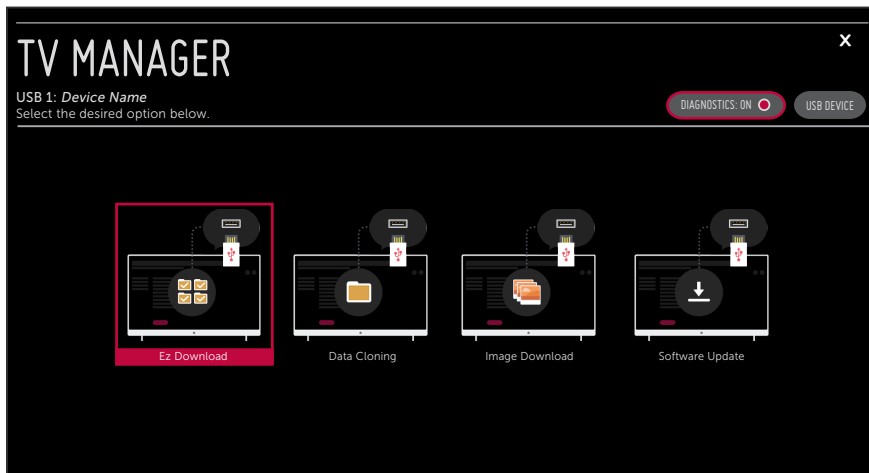

3. Select the appropriate option from the TV Manager, and initiate the desired download(s)/ update(s).

Download/update progress will be displayed on the screen. Do NOT remove the USB device while downloads/updates are in progress. When the process is complete, the TV will reboot. Upon restart, depending on the type of download(s)/update(s) completed, either the EZ-Manager TV Configuration Options screen will be redisplayed (boot logo image and/or software downloads/updates only) or the TV will tune according to the Start Channel setting in the Installer Menu (TV configured with Clone/Configuration file).

Note: If the TV Configuration Options screen is redisplayed (boot logo image and/or software downloads/updates only), you can either proceed with configuration via the EZ-Manager Wizard or exit the EZ-Manager Wizard, as required.

4. Remove the USB memory device, and verify that the appropriate configuration/download(s)/ update(s) is/are resident on the TV.

The Ez Download utility, available from the TV Manager, enables you to select multiple files at one time from the files loaded on a USB memory device. You may use this utility to download any one or all of the following to a TV:

- One Clone or FTG Configuration (.tlx) file
- One TV CPU software update
- One PTC software update
- One boot logo image

Before You Begin

- Ensure the USB device has been formatted with FAT format.
- Software update and image files must be stored in a folder named “LG_DTV” in the root directory of the USB memory device. Clone/Configuration (.tlx) files should simply be stored in the root directory of the USB device.
- If you have initiated the Solution Settings / EZ-Manager Wizard, you can use the wizard’s “USB Configuration” option to access the Ez Download utility, if desired (see “TV Configuration Options” and/or “USB Configuration” on pages 21 and 29, respectively, as necessary).
- If the TV is currently in Pass-through Mode and you intend to use the Zoning feature on this TV for location-specific configuration purposes, make sure to set the appropriate TV Zone # in the TV when directed to do so in the procedure below.
- When creating files to be downloaded, avoid using special characters (?, &, @, etc.) in filenames.
- Refer to “Custom Master TV Setup” on pages 46 to 48 for information on creating a Clone (.tlx) file, and/or refer to “Creating an FTG Configuration File” on pages 55 to 57 for information on creating an FTG Configuration (.tlx) file for FTG Mode via CPU configuration.
- See Reference section, “Downloading a Boot Logo Image using a USB Memory Device,” for boot logo image guidelines.
- See Reference section, “Updating TV/PTC Software using a USB Memory Device,” for further information on software updates.



Caution: Do not unplug the TV power cord or remove the USB memory device during a data download, as doing so may cause the TV to malfunction or harm the USB device, respectively.

Accessing and Using the Ez Download Utility

1. If it is not ON already, turn ON the TV.
2. The next step depends on whether the First Use Wizard appears on the screen when you turn ON the TV:
 - If the wizard is displayed, you can access the Ez Download utility via the EZ-Manager Wizard, as indicated above (see “Before You Begin”). However, to continue with this procedure and access the Ez Download utility from the TV menus, exit the First Use Wizard. Then, continue with step 3.
 - If the wizard is not displayed, go directly to step 3.

(Continued on next page)

Ez Download Utility (Cont.)

(Continued from previous page)

3. If the TV is currently in Pass-through Mode, you would like to transfer (import) a ".tlx" file to the TV via the Ez Download utility, and you intend to use the TV Zoning feature, set the appropriate TV Zone # in the TV at this time. See Reference section, "Using the TV Zoning Feature," for further information.



Note: In order for the proper TV Zone profile data to be applied, the appropriate TV Zone # must be set in the Target TV BEFORE you continue with the Ez Download utility.

4. Insert the USB memory device with the appropriate file(s) into the TV's USB port.
5. To access the TV Manager from the TV menus:
 - Press **MENU SETTINGS** on the Installer Remote to display the TV setup menus (TV is in Pass-through Mode) or the Function Menu (TV is not in Pass-through Mode).
 - If the Quick Settings Menu is displayed at the left of the screen (i.e., the TV is in Pass-through Mode), select the **All Settings**  menu icon and press **OK** to access the advanced TV setup menus.
 - Use the arrow navigation keys to select/highlight either the **General** menu icon from the TV setup menus or the **Safety** menu icon from the Function Menu. Then, press the number "**7**" key a total of seven times.

Note: Ez Download is always selected by default when you initially access the TV Manager. Also note that Diagnostics is for service use only.

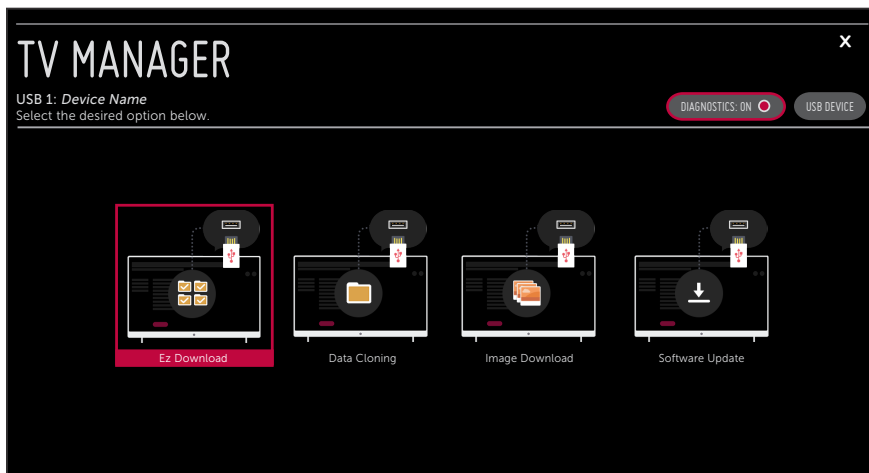

6. If it is not currently selected, use the arrow keys to select **Ez Download**, and then press **OK**.
In the Ez Download screen, a list of files/file types is displayed on the left. Remember that boot logo image, TV software (CPU), and PTC software files must be stored in the LG_DTV folder and Clone/Configuration (.tlx) files must be stored in the root directory on the USB device.

(Continued on next page)

(Continued from previous page)

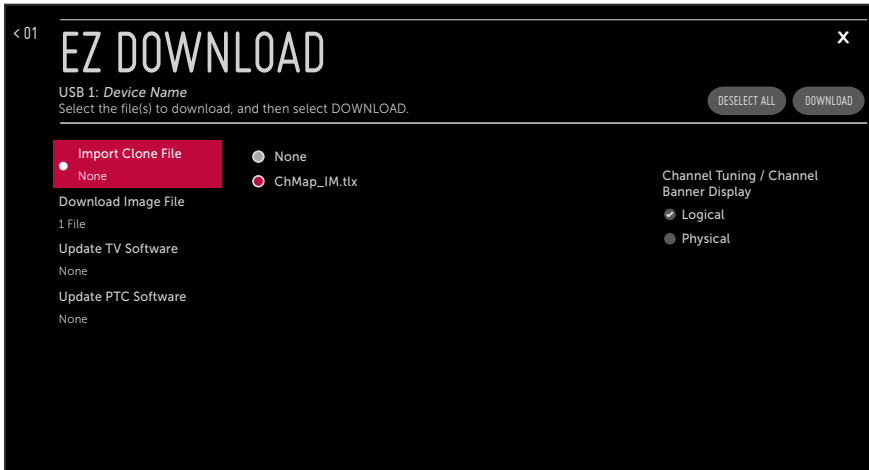

Note: Select the **X** button in the top right corner of the screen, as necessary, to exit the TV Manager. If you accessed the TV Manager via the EZ-Manager Wizard, you will be returned to the last screen on display before you selected the “USB Configuration” option. If you accessed the TV Manager via the TV menus, you will be returned to program viewing. You can also return/navigate to the TV Manager main screen by selecting **< 01** in the top left corner of the Ez Download screen.

7. To select a file:

- Use the arrow keys on the Installer Remote to select/highlight the appropriate file type field, and then press **OK**. A list of available files is displayed to the right of the file type fields.
- Then, use the arrow keys to select the desired file.

Note: The utility will only allow you to select one of each file type for downloading. For example, if there are two files in the Ez Download “Import Clone File” list, you can only select one or the other of those two files.

Note: The initial default value for each file type is “None.” After the Ez Download utility is run, a file is automatically created and stored on the USB device that was used. The file, which will have a “.dzm” file extension, maintains a history of the file(s) previously used with the Ez Download utility. The next time(s) you use this USB device with the Ez Download utility, the file(s) selected for the last download will be pre-selected for the current download, thus facilitating the process of configuring additional TVs of this model using the same USB device. If you ever want to restore the file selections on the Ez Download screen to “None,” select the **DESELECT ALL** button and press **OK**.

Note: The current TV software (CPU) or PTC software version is always displayed above the listing of available TV software and PTC software files, respectively. Ensure the software version of the selected file is the correct version before applying the update to this TV.

(Continued on next page)

Ez Download Utility (Cont.)

(Continued from previous page)

8. If a Clone/Configuration (.tlx) file that includes an FTG Channel Map is selected, a Channel Tuning / Channel Banner Display field will be displayed at the right of the screen, and you can choose the format for the channel tuning/banner display. Use the arrow keys on the Installer Remote to select **Logical** tuning or **Physical** tuning. A checkmark will appear at the left of the selected option. Logical tuning is selected by default.

Note: If the selected “.tlx” file does not include an FTG Channel Map, the message, “No Channel Map in Clone file,” will be displayed at the right of the screen.

9. When you are ready to continue, use the arrow keys on the Installer Remote to select **DOWNLOAD**, and then press **OK**.

Download/update progress will be displayed on the screen. Do NOT remove the USB device while downloads/updates are in progress. When the Ez Download process is complete, an overview of the results will briefly be displayed and then, the TV will reboot.

10. Remove the USB memory device, and verify that the appropriate configuration/download(s)/update(s) is/are resident on the TV.

Note: If you updated the TV configuration with a Clone/Configuration file, upon restart, the TV tunes according to the Start Channel setting in the Installer Menu. If a Start Channel is specified, the TV will tune to that channel, though in the case of FTG Mode via CPU configuration, a channel banner will only be displayed if the Start Channel is included in the FTG Channel Map (depending on your selection in step 8, the channel banner will display either the Start Channel's logical channel number or physical RF channel number). Otherwise, the TV will either return to the last channel tuned (TV in Pass-through Mode) or tune to the first channel in the FTG Channel Map (TV in FTG Mode via CPU). In the latter case, remember that the channels in the FTG Channel Map are always arranged in logical order, regardless of your selection in step 8.

Use the Installer Menu to set up, change, or view operational settings. This section describes how to access, use, and exit the Installer Menu from the TV itself. However, you should also refer to the Installer Menu descriptions in this document if you are configuring the TV CPU using an FTG Configuration (.tlx) file created using LG's Cloud Configuration Tool or configuring the EBL locally (.rml) or remotely (via FMA-LG102 / .fma) using the FTG Device Configuration Application software.

Refer to the table on pages 37 and 38 for brief descriptions of Installer Menu items. More detailed descriptions follow the table listing.

Accessing the Installer Menu

1. Turn ON the TV.

If the First Use Wizard appears on the screen when you turn ON the TV, exit the wizard.

2. Using an Installer Remote, press **MENU SETTINGS** repeatedly until the on-screen display of the TV setup menus (if the TV is in Pass-through Mode) or the Function Menu (if the TV is not in Pass-through Mode) no longer toggles, and then press the Installer Menu entry sequence (e.g., **9-8-7-6**) + **OK** to access the Installer Menu.

Note: The default Installer Menu entry sequence is "9876"; however, if Installer Menu item 000 INSTALLER SEQUENCE has been modified, the entry sequence may be one of three additional options. See Installer Menu detailed descriptions for further information.

The Installer Menu opens with item 000 INSTALLER SEQ 000.

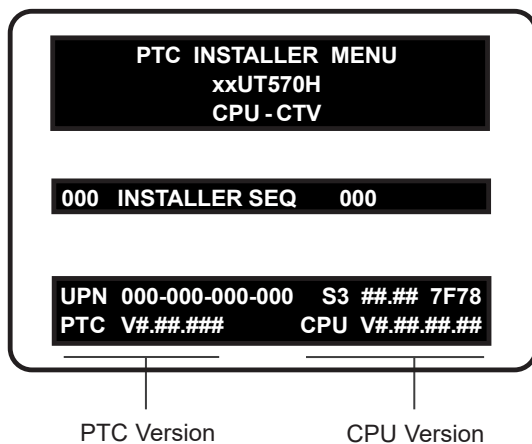

Typical Installer Menu

The Installer Menu header will vary depending on the TV you are setting up. In the Installer Menu footer, you can see the current software versions of the TV, as indicated.

Note: If the password (entry sequence) is not entered or registered correctly, you will see the message "ENTER PASSWORD 0000" at the top of the screen instead of the Installer Menu header. Once you re-enter the correct password (e.g., press 9-8-7-6 + OK), the Installer Menu will display.

Note: If the TV is not in Pass-through Mode, the Installer Menu is accessible as read-only. Also, the TV Zone # will be indicated in the Installer Menu header under the configuration mode indicator described below.

Installer Menu (Cont.)

As part of the Installer Menu header (in all modes), two 3-character acronyms are displayed to indicate the TV's current configuration mode. The table below lists all possible mode identifiers for these TV models.

Acronym	Description
CPU-CTV	Pass-through Mode with Channel Lineup in CPU
CPU-FTG	FTG Mode via CPU
CPU-P:C	Application Tuning Mode via CPU
EBL-FTG	FTG Mode via EBL
EBL-LNT	SONIFI PPV Mode
MPI-EXT	External MPI Control
PTC-CTV	Pass-through Mode with Channel Map in PTC

Navigating Within the Installer Menu

Use the Up/Down arrow keys on the Installer Remote to sequence through the available menu items, or access an item directly by keying in the item number and then pressing **MENU SETTINGS**. For example, to access the SLEEP TIMER option, which is item 015, press 0-1-5 + MENU SETTINGS.

Installer Menu items not relevant to these TV models are not present in the Installer Menu; therefore, some numbers are missing. For example, item 006 will not appear. In addition, items that are dependent on other Installer Menu item settings will not be initially accessible. For example, item 046 STRT AUX SRCE will not display in the Installer Menu unless item 004 STRT CHANNEL is set to 0. See Installer Menu detailed descriptions for further information.

Modifying Installer Menu Settings

Refer to the table starting on the next page for an overview of the available Installer Menu items, including their item numbers, functions, value ranges, and default values.

To change an Installer Menu item value, use the Left/Right arrow keys on the Installer Remote to select the appropriate value, or direct enter a valid value. To save the new setting, press **OK** once on the Installer Remote. If you have additional items to modify, use the Up/Down arrow keys to navigate to a new Installer Menu item or access an item directly as described in the previous section. Note that invalid values will not be saved.



Caution: In order for Installer Menu item changes to be saved, you must press **OK** as indicated above and then exit the Installer Menu as described below. Never remove power from the TV while in the Installer Menu. Also, remember that Installer Menu settings may affect options available from the TV setup menus or the Function Menu.

Exiting the Installer Menu and Activating Settings

After you have saved all desired Installer Menu item changes (i.e., press **OK** once on the Installer Remote to save changes), press **OK** again to exit the Installer Menu. Any changes you make will be stored in non-volatile memory.

Note: Each time you exit the Installer Menu in Pass-through Mode, all V-Chip (Parental Control) settings in the TV are reset to their default values; that is, the Lock System, if previously enabled from the Safety Menu, will now be disabled, and the individual Parental Control settings will be restored to default values.

Installer Menu (Cont.)

Installer Menu Items 000 through 071

Item	Function	Value Range	Default Value	Brief Description of Function
000	INSTALLER SEQ	0–3	0	Leave default set to 0.
001	POWER MANAGE	0–7	0	Selects the number of hours of inactivity allowed before the TV automatically turns itself OFF. Set to 0 to disable Power Management.
002	AC ON	0–3, 16–19	0	Determines the status of the TV (ON, Instant ON enabled, etc.) when AC power is applied. See detailed descriptions.
003	BAND/AFC	0–3	1	Selects the RF Tuning Band: 0=Broadcast, 1=Cable, 2=HRC, 3=IRC
004	STRT CHANNEL	0–127, 255	255	Channel tuned when the TV is turned ON. (Set to 255 to tune to channel tuned before the TV was turned OFF.)
005	CHAN LOCK	0 / 1	0	If set to 1, cannot tune from current channel.
007	STRT VOLUME	0–63, 255	255	Volume level when the TV is turned ON. (Set to 255 to use volume level set before the TV was turned OFF.)
008	MIN VOLUME	0–63	0	Sets the minimum allowable volume setting.
009	MAX VOLUME	0–63	63	Sets the maximum allowable volume setting.
010	MUTE DISABLE	0 / 1	0	Set to 1 to disable the Mute function.
015	SLEEP TIMER	0 / 1	1	Set to 1 to enable the Sleep Timer feature.
016	EN TIMER	0 / 1	0	Set to 1 to enable On/Off timers.
017	ALARM	0 / 1	1	Set to 1 to enable the Alarm feature in the Function Menu.
020	FEATURE LEVEL	0, 16–24	0	Determines an additional IR code scheme to which the TV will respond.
021	V-CHIP	0 / 1	1	Set to 1 to enable V-Chip (Parental Control) functions.
022	MAX BLK HRS	0–99	12	Determines the number of Parental Control blocking hours that can be set in the Function Menu.
023	CAPTION LOCK	0 / 1	0	Set to 1 to retain the caption setting selected before the TV was turned OFF.
028	CH. OVERRIDE	0 / 1	1	If set to 0, users can only tune to channels that are included in the PTC Channel Map. See detailed descriptions.
029	REMAP AUX INPS	0 / 1	0	Set to 1 to remap the PTC's direct tune channels for Aux inputs from 13x to 9x.
030	ACK MASK	0 / 1	0	If set to 1, enables the ACK feature of MPI.
031	POLL RATE	20–169	94	Selects the poll rate for MPI.
032	TIMING PULSE	186–227	207	Sets the baud rate for MPI.
035	HDMI1 ENABLE	0–2	1	Set to 0 to disable HDMI 1. Set to 1 (DTV Mode) or 2 (PC Mode), as applicable, to enable HDMI 1.
039	REAR AUX EN.	0 / 1	1	Set to 1 to enable the display panel AV input jack.
041	SIMPLINK EN	0 / 1	0	Determines the status of the SIMPLINK feature. See detailed descriptions.
042	AUTO INPUTS	0–255	0	Determines the Aux inputs for which auto-sensing is enabled. See detailed descriptions.
046	STRT AUX SRCE	1, 3, 5, 7, 255	7	Sets the starting Aux source (if item 004 STRT CHANNEL is set to 0).
047	AUX STATUS	0 / 1	0	Controls the MPI status channel response for Aux sources. Set to 1 for the Aux source to be reported as its channel number.
049	DIS. AUDIO M.	0–5, 8–11	0	Determines the availability of the Sound Out (Audio) Menu in the TV menus, as well as the default Audio Mode when the TV is turned ON. See detailed descriptions.
053	DIS. CH-TIME	0 / 1	0	Set to 1 to disable the TV's native Channel-Time display.
069	EN. CH-T COL.	0 / 1	1	Set to 1 to enable custom color for MPI display characters.
070	FOR. CH-TIME	0–7	2	Chooses custom foreground color for MPI display characters.
071	BCK. CH-TIME	0–7	2	Chooses custom background color for MPI display characters.

Installer Menu (Cont.)

Installer Menu Items 073 through 122

Item	Function	Value Range	Default Value	Brief Description of Function
073	CH NOT AVBLE	0 / 1	0	If set to 1 and item 028 CH. OVERRIDE is set to 0, a "CHANNEL NOT AVAILABLE" message is displayed if the user attempts to direct tune a channel that is not included in the channel lineup.
075	REVERT CH	0 / 1	0	If set to 1 and loss of MPI communication occurs, the TV tunes to the Start Channel.
078	UPN MSB	0–255	0	User programmable number, most significant byte.
079	UPN MSB-1	0–255	0	User programmable number, most significant byte - 1.
080	UPN MSB-2	0–255	0	User programmable number, most significant byte - 2.
081	UPN LSB	0–255	0	User programmable number, least significant byte.
082	CHKSM ERROR	0 / 1	1	Enforces rigid MPI checksum.
083	HANDSHK TIME	0–5	5	Determines the MPI timing requirement of an MPI command to follow an MPI Status Response.
084	PERMANENT BLK	0 / 1	0	Set to 1 to remove the blocking hours setting in the Function Menu for Parental Control and make the block permanent.
088	EN NOISE MUTE	0 / 1	1	(Analog channels only) If set to 1, audio is muted if no signal is present.
090	KEY LOCK	0 / 1	0	If set to 1, the display panel power button function is locked. IR is still functional.
091	HDMI2 ENABLE	0–2	1	Set to 0 to disable HDMI 2. Set to 1 (DTV Mode) or 2 (PC Mode), as applicable, to enable HDMI 2.
092	HDMI3 ENABLE	0–2	1	Set to 0 to disable HDMI 3. Set to 1 (DTV Mode) or 2 (PC Mode), as applicable, to enable HDMI 3.
093	RJP AVAILABLE	0, 1, 2, 5, 6	0	Set to 0 to disable. Set to 1, 2, 5, or 6 for HDMI or DVI Mode. See detailed descriptions.
094	SAP MENU EN	0 / 1	1	Set to 1 to enable the SAP feature in the Function Menu.
096	DEF. ASP. RATIO	0–4	2	Selects the default aspect ratio. See detailed descriptions.
097	AUDIO OUTPUT	0–9*	7	Set as required in accordance with external audio equipment connected to the TV. See detailed descriptions.
		0, 9, 10**	9	
098	PRO:CENTRIC	0, 2, 3	0	Set to 0 to disable the Pro:Centric application. Set to 2 for GEM (Java Application) Mode. Set to 3 for HTML Mode.
099	BACK LIGHTING	1–202, 255	255	Sets the level of the TV picture back lighting. See detailed descriptions.
102	ATSC BAND	0–4	4	Selects the RF band used by the ATSC tuner. See detailed descriptions.
103	ATSC TUNE MODE	0 / 1	1	Set to 1 for Physical Channel tuning. Set to 0 for Virtual Channel tuning.
104	START MINOR CH	0–255	0	Selects the Minor Start Channel number. Set to 0 for analog (NTSC) channel.
106	ASP RATIO LOCK	0 / 1	0	Set to 0 to use the default aspect ratio each time the TV is turned ON. Set to 1 to retain the aspect ratio set before the TV was turned OFF.
107	BANNER SELECT	0 / 1	1	Selects the type of banner to display during channel change.
116	VIDEO MUTE EN	0 / 1	0	(Analog channels only) If set to 1, video mutes (blank screen) when no signal is present.
117	FACT DEFAULT	0 / 1	0	Set to 1 to restore the factory default settings of all Installer Menu items.
118	POWER SAVINGS	1, 3, 7	3	Determines the powered status of the embedded b-LAN module and the GAME CONTROL/MPI port. See detailed descriptions.
119	DATA CHANNEL	0–135, 253, 255	255	Set to 0 to disable. Set from 1 to 135 to match the RF channel number used by the Pro:Centric server as its data channel. Set to 255 to use Auto Search to find the Pro:Centric RF channel. See detailed descriptions.
121	UPDATE TIME HR	0–23, 128, 255	128	Sets the Wake For Update hour. See detailed descriptions.
122	UPDATE TIME MN	0–59, 255	0	Sets the minute for Wake For Update. See detailed descriptions.

* UT570H0Ux/UT577H0Ux models support values 0–9. ** UT570H9Ux models support values 0, 9, 10.

Detailed Descriptions of Installer Menu Items

000 - INSTALLER SEQUENCE

Specifies entry sequence to the Installer Menu.

0 = 9876 1 = 4321
2 = 1478 3 = 3698

001 - POWER MANAGE (Power Management)

Energy saving feature. Determines the number of hours, in the range 1 to 7, of inactivity allowed, either at the TV control panel or from the remote, before the TV automatically turns itself OFF. If set to 0, Power Management is disabled.

002 - AC ON (AC Power Switchable)

Determines the status of the TV when AC power is applied. Set to 0 (default) for standard TV turn ON/OFF operation. Set to 16 if you would like the TV to turn ON the first time AC power is applied, after which the TV will be configured for standard ON/OFF operation.

If set to 1 or 17, the TV will turn ON when AC power is applied. Pressing the POWER button is not necessary. This is desirable if the TV is plugged into a switched AC outlet (i.e., a set-top box). Though note that if the Pro:Centric application is loaded (i.e., item 098 PRO:CENTRIC is not set to 0), the TV will reboot and initiate an update once every 24 hours.* During the update event, the TV checks for and downloads any available updates from the Pro:Centric server (item 119 DATA CHANNEL set from 1 to 135 or 253). The time at which this event occurs depends on the setting of item 121 UPDATE TIME HR. See item 119 and 121 descriptions for further information. Once the update cycle is complete, the TV completes the reboot and resumes its ON state.

Note: If set to 1 or 17, the TV does not respond to ON/OFF commands from either the remote or the display panel, and the Sleep Timer is also nonfunctional.

Set to 2, 3, 18, or 19 to enable the Instant ON feature, as required. The Instant ON feature allows the TV to turn ON when AC power is applied, but with video and audio muted (Muted ON). The TV remains powered ON while appearing to be OFF. Pressing the POWER button toggles off/on the video and audio mutes, so that the TV appears to turn ON instantly. Set to the appropriate value to enable Instant ON with reboot (value 2 or 18) or Instant ON without reboot (value 3 or 19), respectively. See bullets below for further information on reboot functionality. See also note below.

Note: Values 2 and 3 represent standard Instant ON functionality; i.e., when AC power is applied, the TV is in a Muted ON state. If set to 18 or 19, the Instant ON feature allows the TV to turn ON, without muting video and audio, when AC power is initially applied.

- Instant ON with reboot: The TV will reboot and, if applicable (i.e., item 119 DATA CHANNEL set from 1 to 135 or 253), check for and download any available updates from the Pro:Centric server at every turn OFF. This setting is not recommended if the TV will be configured with a resident application.

- Instant ON without reboot: The TV will not reboot to check for and download updates at turn OFF, with the following exception: the first time the TV is turned OFF after this item is set to 3 or 19, the TV will reboot and initiate an update event (Data Channel Auto Search and/or check for and download of updates—see also paragraph below). This setting is recommended if the TV will be configured with a resident application. In this mode, the standard check for and download of updates is under application control. Refer to your site-specific documentation for further information on configuring the TV with a resident application.

When this item is set to 2, 3, 18, or 19, the TV also will reboot and initiate an update event once every 24 hours. During the update event, the TV, as applicable, performs a Data Channel Auto Search (item 119 set to 255) and/or checks for and downloads any available updates from the Pro:Centric server (item 119 set from 1 to 135 or 253). The time at which this event occurs depends on the setting of item 121 UPDATE TIME HR. See item 119 and 121 descriptions for further information. Once the update cycle is complete, the TV completes the reboot and resumes its Muted ON state.

Note: Instant ON is not supported when the TV is in MPI-EXT Mode, EBL-LNT Mode, or FTG Mode via EBL.

003 - BAND/AFC (Tuning Band)

Selects the RF band used by the NTSC tuner:

0 = Broadcast 1 = Cable (default)
2 = HRC 3 = IRC

Determine the RF band used by the RF distribution system, and then select the appropriate value for this item before tuning channels or running Channel Tuning (Channel Search). See also item 102 ATSC BAND.

004 - STRT CHANNEL (Start Channel)

If active, this function allows you to determine the initial Major Start Channel number when the TV is turned ON. This feature is useful for an in-house information channel, since the TV would always select that channel when it is turned ON. If set to 255, the last channel tuned before the TV was turned OFF will be the channel tuned when the TV is turned ON again.

0 = Aux 127 = Map to Major CH 4
1 – 125 = Major Ch. # 255 = Last Channel
126 = Map to Major CH 3

For a digital (ATSC) Start Channel, always remember to set item 104 to the Minor Start Channel number. If setting this item to 0 (Aux), make sure to also set item 046 STRT AUX SRCE to the appropriate value.

Note: 126 and 127 are mapped only in SONIFI PPV Mode.

* Exception: If the TV is externally rebooted within the previous 24 hours, the subsequent update event will take place at the next designated reboot time, which could be up to 48 hours from the time of the external reboot.

Installer Menu (Cont.)

Note: If the TV is being configured for Application Tuning Mode operation with Pro:Centric Direct, the Start Channel is set in the Pro:Centric Direct Admin Client, and Installer Menu item 004 is automatically updated accordingly. When the TV is in Application Tuning Mode, the appropriate values will be visible in the (read-only) Installer Menu. For an RF Start Channel, item 004 will show the channel's Major and Minor numbers.

005 - CHAN LOCK (Channel Lock)

Channel Lock is ideal if the system must always be on the same channel. If set to 1, Channel Lock is enabled and it is not possible to change channels. If set to 0 (default), Channel Lock is disabled. Generally, this feature is used in connection with item 004 STRT CHANNEL where the Start Channel may, for example, be set to 3 or 4. If the Start Channel is 3, then the TV will remain locked on channel 3.

NOTE: For items 007, 008, and 009

For legacy reasons, the scale used is 0–63. The PTC software will translate this to the 0–100 scale used by the TV.

To translate a TV volume level to the Installer Menu value, use the following formula:

$$\text{Installer Value} = \frac{\text{TV Value} \times 63}{100}$$

Enter only the whole number (disregard fractions).

007 - STRT VOLUME (Start Volume)

This function allows you to determine the initial volume level setting when the TV is turned ON. This feature is useful for an in-house information channel, since the TV will always select that volume level when it is turned ON. The range of values is 0 to 63, 255. If set to 255, the last volume level before the TV was turned OFF will be the current volume level when the TV is turned ON again.

Note: The factory default volume level (i.e., when AC power is initially applied) for these TV models is 20. In addition, if AC power is removed/disconnected and then reapplied to the TV while this item is set to 255, the TV volume level will revert to 20 when the TV is turned ON again.

008 - MIN VOLUME (Minimum Volume)

This function determines the minimum volume level allowable with the Volume (VOL) Up/Down control. In this way, for example, someone cannot set the volume too low to hear. The value range is from 0 to 63. The factory default is 0, which provides the full range of volume control, if item 009 MAX VOLUME is set to 63. It is recommended to set the same value on every TV.

Note: The minimum volume level cannot have a value setting higher than the maximum volume level (described below).

009 - MAX VOLUME (Maximum Volume)

This function determines the maximum volume level allowable with the Volume (VOL) Up/Down control. In this way, for example, someone cannot set the volume level high enough to disturb others. The value range is 0 to 63, with 63 as the default, which gives the end user the full range of volume control, if item 008 MIN VOLUME is set to 0. It is recommended to set the same value on every TV.

Note: The maximum volume level cannot have a value setting lower than the minimum volume level (described above).

010 - MUTE DISABLE

Enables or disables the sound Mute function. If set to 1, sound cannot be muted. If set to 0, sound can be muted.

015 - SLEEP TIMER

If set to 1, the Sleep Timer feature is enabled and available to the end user. Set to 0 to disable the Sleep Timer feature.

016 - EN TIMER (Enable On/Off Timers)

If set to 1, the Timer function is enabled and available to the end user. Set to 0 to disable On/Off timers.

Note: The TV clock must be set in order for timers to be used.

017 - ALARM

If set to 1, the Alarm feature is enabled and available to the end user in the Function Menu (i.e., the TV is not in Pass-through Mode). Set to 0 to disable the Alarm feature.

Note: The TV clock must be set before the Alarm feature will work.

020 - FEATURE LEVEL

Determines an additional IR code scheme to which the TV will respond, allowing for the use of unique IR codes based on "bed number" in a multi-TV single room installation. First determine the IR mode; then select the bed number.

Values	IR Mode	Bed #
0	Disabled	N/A
16–24	Multi-code Remote	1–9

Note: For further information, see documentation for the accessory package that includes the multi-code remote.

021 - V-CHIP (Parental Control)

Set to 1 to activate V-Chip (Parental Control) and have it available to the end user to filter and control or otherwise restrict programming content that can appear. Set to 0 to turn off the V-Chip feature (not available to end user); no programming restrictions can be set.

022 - MAX BLK HRS (Maximum Block Hours)

Sets hours from 0 to 99 for the maximum number of Parental Control blocking hours that can be set in the Function Menu (i.e., the TV is not in Pass-through Mode). Default setting is for 12 blocking hours.

Note: This item is not available in the Installer Menu when item 021 V-CHIP is set to 0 or when item 084 PERMANENT BLK is set to 1.

023 - CAPTION LOCK

If set to 0, captions are off when the TV is turned ON. If set to 1, the caption setting selected before the TV was turned OFF will be the current caption setting when the TV is turned ON again.

028 - CH. OVERRIDE (Channel Override)

This item either allows or restricts tuning of channels that are NOT in the PTC Channel Map. If set to 1, end users can tune channels that are not in the PTC Channel Map by direct keypad entry. If set to 0, end users are restricted to only the channels that are in the PTC Channel Map. In the case of CPU-CTV Mode, there are no channels in the PTC Channel Map; therefore, direct keypad entry is not available. Also, when this item is set to 0, the PTC Channel Map (PTC-CTV Mode)/CPU channel lineup (CPU-CTV Mode) is locked, and end user access to channel settings in the TV setup menus is restricted.

Note: This item is not applicable when the TV is in FTG Mode or Application Tuning Mode.

029 - REMAP AUX INPS

Set to 1 to remap the PTC's direct tune channels for Aux inputs from 13x to 9x. This allows 2-digit only tuning systems (i.e., legacy On Command Video™) to direct tune Aux inputs. See also Reference section, "TV Aux Input Configuration."

030 - ACK MASK

MPI Communication Parameter. When set to 1, enables the ACK feature of MPI.

031 - POLL RATE

MPI Communication Parameter. Selects the poll rate for MPI. Step size of 16 ms. Changing from default may affect communication via MPI.

032 - TIMING PULSE

MPI Communication Parameter. Sets the baud rate for MPI. Step size of 4.3 uS. Changing from default may affect communication via MPI.

035 - HDMI1 ENABLE

Set to 1 to enable HDMI 1 input in DTV Mode. Set to 2 to enable HDMI 1 input in PC Mode. Set to 0 to disable display panel HDMI 1 input.

Note: This setting is ignored if item 093 RJP AVAILABLE is set to 1.

039 - REAR AUX EN. (Rear Aux Enable)

Set to 1 to enable the display panel rear Aux (AV) input. Set to 0 to disable the display panel rear Aux (AV) input.

041 - SIMPLINK EN

Set to 0 to disable the SIMPLINK feature. Set to 1 to enable SIMPLINK functionality (does not enable remote control access to the SIMPLINK Menu).

Note: When both this item *and* item 042 AUTO INPUTS are enabled in the Installer Menu, HDMI inputs will be detected by SIMPLINK, but the Auto Input(s) Sensing Feature will not function.

042 - AUTO INPUTS

Determines the Aux inputs for which auto-sensing is enabled. Set to 0 to disable auto-sensing for all available inputs. Set to 255 to enable auto-sensing for all available inputs. For information on options for individual input settings, see Reference section, "Auto Input(s) Sensing Feature."

Note: In order for auto-sensing to be enabled for an input, that input must also be enabled in the Installer Menu. For example, to enable auto-sensing for HDMI 1, item 035 HDMI1 ENABLE must also be set to 1 or 2. Also, see note above regarding TV operation when both this item and item 041 SIMPLINK EN are enabled.

Note: When this item is enabled in the Installer Menu, item 093 RJP AVAILABLE is automatically set to 0.

046 - STRT AUX SRCE (Start Aux Source)

Sets the starting Aux source. When turned ON, the TV will tune to the starting Aux source if item 004 STRT CHANNEL is set to 0.

1 = AV 3 = HDMI 1 5 = HDMI 2
7 = HDMI 3 255 = Last Aux

Note: In order for an Aux input to be selected as the starting Aux source, the input also must be enabled in the Installer Menu.

Note: This item is not available in the Installer Menu unless item 004 STRT CHANNEL is set to 0.

047 - AUX STATUS

Controls the MPI status channel response for Aux sources. Set to 1 for the Aux source to be reported as its channel number. Set to 0 for the Aux source to be reported as channel 0. See Reference section, "TV Aux Input Configuration," for Direct Access channel numbers.

049 - DIS. AUDIO M. (Disable Audio Menu)

Determines the availability of the Sound Out (Audio) Menu in the TV menus. Also determines the default Audio Mode when TV is turned ON. See the table below and set as required.

Value	Sound Out Menu Status	Default Audio Mode at TV Turn ON
0 (default)	Enabled	TV Speaker
1	Disabled	TV Speaker
2	Enabled	External Speaker (Optical)
3	Disabled	External Speaker (Optical)
4	Enabled	LG Sound Sync (Optical)
5	Disabled	LG Sound Sync (Optical)
8	Enabled	TV Speaker + Audio Out (Optical)
9	Disabled	TV Speaker + Audio Out (Optical)

Installer Menu (Cont.)

10	Enabled	External Speaker (HDMI ARC)
11	Disabled	External Speaker (HDMI ARC)

Note: Values 10 & 11 are only available if item 041 SIMPLINK EN is set to 1 (enabled).

Note: If a SIMPLINK-enabled device is connected to the TV and item 041 SIMPLINK EN is set to 1 (enabled), the SIMPLINK device Audio Mode will have priority over the setting of this item when the TV is turned ON.

053 - DIS. CH-TIME (Disable Channel-Time Display)

Set to 1 to disable the TV's native Channel-Time display when a custom channel label/channel information will be provided by the MPI command. Set to 0 to enable the TV's native Channel-Time display.

069 - EN. CH-T COL. (Enable Display Characters Custom Color)

Set to 1 to enable custom color for MPI display characters. Set to 0 to disable custom color for MPI display characters.

070 - FOR. CH-TIME (Display Characters Foreground Color)

Set the foreground color for MPI display characters according to the following color chart:

0 = Black 2 = Green 4 = Red 6 = Yellow
1 = Blue 3 = Cyan 5 = Violet 7 = White

If the foreground and background colors for the display characters are the same, the background will be transparent.

Note: This item and item 071 BCK. CH-TIME also apply to the "Channel Not Available" message if item 073 CH NOT AVBLE is set to 1 (enabled).

Note: Items 070 FOR. CH-TIME and 071 BCK. CH-TIME are only available in the Installer Menu when item 069 EN. CH-T COL. is set to 1.

071 - BCK. CH-TIME (Display Characters Background Color)

See description for item 070 FOR. CH-TIME above. The color chart is the same for both items.

073 - CH NOT AVBLE (Channel Not Available)

If set to 1 and item 028 CH. OVERRIDE is set to 0, a "CHANNEL NOT AVAILABLE" message is displayed when a user attempts to direct tune a channel that is not included in the channel lineup.

Note: This item is not available in the Installer Menu when item 028 CH. OVERRIDE is set to 1.

Note: This item is only applicable when the TV is in PTC-CTV Mode.

075 - REVERT CH (Revert to Start Channel)

If set to 1 and loss of MPI communication occurs, the TV automatically tunes to the specified Start Channel.

Note: This item is not available in the Installer Menu when item 004 STRT CHANNEL is set to 255. This item also is not available in the Installer Menu when item 004 STRT CHANNEL is set to 0 and 046 STRT AUX SRCE is set to 255.

078 - UPN MSB (UPN Most Significant Byte)

User programmable number, most significant byte readable by MPI command. Note: Not linked to serial number.

079 - UPN MSB-1 (UPN Most Significant Byte-1)

User programmable number, most significant byte-1 readable by MPI command. Note: Not linked to serial number.

080 - UPN MSB-2 (UPN Most Significant Byte-2)

User programmable number, most significant byte-2 readable by MPI command. Note: Not linked to serial number.

081 - UPN LSB (UPN Least Significant Byte)

User programmable number, least significant byte readable by MPI command. Note: Not linked to serial number.

082 - CHKSM ERROR (Checksum Error)

Enforces rigid MPI checksum validation. Set to 1 for validation. Set to 0 to disable (does not check checksum on MPI async port). SPI is always checked.

083 - HANDSHK TIME (Handshake Time)

Determines the MPI timing requirement of the (STB's) MPI command to follow the end of the transmission of the (display's) MPI Status Response. Value range is 0 to 5. Changing from default may affect communication via MPI. (Handshake Time = 25.5 ms + [25.5 ms x item value])

084 - PERMANENT BLK (Permanent Block)

Allows Parental Control blocking schemes to be permanent by disabling the end user's ability to limit blocking hours in the Function Menu. Set to 1 to install Parental Control restrictions permanently. Set to 0 for end user-specified hours control of blocking schemes. See also item 022 MAX BLK HRS.

Note: This item is not available in the Installer Menu when item 021 V-CHIP is set to 0.

088 - EN NOISE MUTE (Enable Noise Mute)

Applicable for analog channels only. If set to 1, audio mutes if no signal is present.

090 - KEY LOCK

If set to 1, Key Lock is enabled, which means that the display panel power button function will be locked, i.e., non-functional. Set to 0 to disable Key Lock. Note that all IR features remain functional regardless of this setting.

091 - HDMI2 ENABLE

Set to 1 to enable HDMI 2 input in DTV Mode. Set to 2 to enable HDMI 2 input in PC Mode. Set to 0 to disable display panel HDMI 2 input.

092 - HDMI3 ENABLE

Set to 1 to enable HDMI 3 input in DTV Mode. Set to 2 to enable HDMI 3 input in PC Mode. Set to 0 to disable display panel HDMI 3 input.

093 - RJP AVAILABLE (Remote Jack Pack Available)

- 0 = Remote jack pack is not available or disabled.
- 1 = Legacy Model RJP: HDMI Mode
Enables RJP feature for use with full cable bundle models. In this mode, when an HDMI source is connected to the RJP, both digital video and audio are expected via the HDMI cable. If no digital audio is present, no audio will be heard.
- 2 = Legacy Model RJP: DVI Mode
Enables RJP feature for use with full cable bundle models. In this mode, when an HDMI/DVI source is connected to the RJP, only digital video is expected via the HDMI cable. Analog audio is provided via a separate cable, from the source, connected to an RJP AUDIO IN. If no analog audio cable is connected, tuner audio will be heard.
- 5 = Scaler Model RJP: HDMI Mode
Enables RJP feature for use with reduced cable bundle models. In this mode, when an HDMI source is connected to the RJP, both digital video and audio are expected via the HDMI cable. If no digital audio is present, no audio will be heard.
- 6 = Scaler Model RJP: DVI Mode
Enables RJP feature for use with reduced cable bundle models. In this mode, when an HDMI/DVI source is connected to the RJP, only digital video is expected via the HDMI cable. Analog audio is provided via separate cable, from the source, connected to an RJP AUDIO IN. If no analog audio cable is connected, tuner audio will be heard.

Note: See also Reference section, "RJP Model List & Input Auto-sensing Hierarchy." Settings 1, 2, 5, and 6 allow the lodge staff to customize each TV's RJP setup based on customer requirements.

Note: When this item is enabled in the Installer Menu, item 042 AUTO INPUTS is automatically set to 0.

094 - SAP MENU EN (2nd Audio Program)

Set to 1 to enable the SAP feature in the Function Menu (i.e., the TV is not in Pass-through Mode). Set to 0 to disable the SAP feature in the Function Menu.

096 - DEF. ASP. RATIO (Default Aspect Ratio)

Selects the aspect ratio to be set as default each time the TV is turned ON:

- 0 = Set By Program 1 = 4:3 2 = 16:9 (default)
3 = Just Scan 4 = Zoom

Note: See also item 106 ASP RATIO LOCK. This item (i.e., item 096) is not available in the Installer Menu when item 106 is set to 1.

097 - AUDIO OUTPUT

- For UT570H0Ux/UT577H0Ux models: Determines availability and signal type/level (fixed speaker, variable speaker, or fixed line level [amplifier]) of the audio output to be used by external audio equipment connected to the SPEAKER OUT / LINE OUT jack on the TV. Set to 0 to disable audio output. Otherwise, see the table below and set as required in accordance with audio equipment. See also Reference section, "External Speaker/Audio Line Out Specifications."

	Value	Status
Speaker Output	1	Fixed 0.01 Watts
	2	Fixed 0.03 Watts
	3	Fixed 0.05 Watts
	4	Fixed 0.10 Watts
	5	Fixed 0.20 Watts
	6	Fixed 0.50 Watts
	7	Fixed 1.00 Watt (default)
	8	Control with volume
Line Output	9	Fixed line level (typically 400 mVrms ± 100 mVrms @10KΩ) output

- For UT570H9Ux models: Determines availability of the analog audio output to be used by external audio equipment connected to the AUDIO LINE OUT jack on the TV. Set to 0 to disable audio output. Otherwise, see the table below and set as required in accordance with audio equipment. See also Reference section, "External Speaker/Audio Line Out Specifications."

	Value	Status
Line Output	9	Fixed line level (typically 400 mVrms ± 100 mVrms @10KΩ) output
	10	Control with volume

098 - PRO:CENTRIC

Selects the Pro:Centric Application Mode. Set to 0 (default) to disable the Pro:Centric application. Set to 2 for GEM (Java Application) Mode. Set to 3 for HTML Mode.

Once you exit the Installer Menu, turn OFF the TV for at least one minute to initiate the Pro:Centric application download. When you turn the TV back ON, wait several minutes to allow the TV to load the Pro:Centric application after the initial download. Then, press the PORTAL key on the Installer Remote, and verify that the Pro:Centric application appears on the display.

Note: This item is not available in the Installer Menu when item 119 DATA CHANNEL is set to 0.

Installer Menu (Cont.)

099 - BACK LIGHTING

Sets the TV screen brightness. Default setting is 255.

- 1 (dimpest picture)– 100 (brightest picture) Static Back Lighting
- 101 (dimpest picture)– 200 (brightest picture) Dynamic Back Lighting: The TV automatically controls back lighting depending upon the picture level of the current program.
- 201 Automatic Static Back Lighting: The TV automatically controls back lighting by using Intelligent Sensor to detect the level of ambient lighting.
- 202 Automatic Dynamic Back Lighting: The TV automatically controls back lighting by using Intelligent Sensor to detect the level of ambient lighting and depending upon the picture level of the current program.

If set to 201 or 202, back lighting can be controlled via the Picture settings in the TV setup menus. However, each time the TV is turned ON, Picture Mode (set in Picture Menu) is defaulted to Intelligent Sensor. If Picture Mode is manually set to a static option (Vivid, Standard, etc.) during a viewing session, Intelligent Sensor is temporarily disabled.

If set to 255, back lighting is controlled via the Picture settings in the TV's setup menus.

102 - ATSC BAND

Selects the RF band used by the ATSC tuner.

0 = Broadcast 1 = Cable 2 = HRC
3 = IRC 4 = Same as NTSC (default)

103 - ATSC TUNE MODE

Sets the ATSC tuning mode. Set to 1 (default) for Physical Channel tuning. Set to 0 for Virtual Channel tuning.

Note: This item must be set to 1 (Physical Channel tuning) to support Pro:Centric RF data channel operation. See also item 119 DATA CHANNEL.

104 - START MINOR CHANNEL

When a digital (ATSC) Start Channel has been specified for item 004 STRT CHANNEL, this item sets the Minor Start Channel number. Set to 0 when an analog (NTSC) Start Channel has been specified for item 004.

Note: This item is not available in the Installer Menu when item 004 STRT CHANNEL is set to 0 or 255.

106 - ASP RATIO LOCK (Aspect Ratio Lock)

Set to 0 to use the default aspect ratio each time the TV is turned ON (see item 096 DEF. ASP. RATIO). If set to 1, the aspect ratio set before the TV was turned OFF will be the current aspect ratio when the TV is turned ON again.

107 - BANNER SELECT

Selects the type of banner to display during channel change. Set to 1 for channel label display, plus channel information (full banner). Set to 0 for channel label display only (small banner).

116 - VIDEO MUTE EN (Video Mute Enable)

Applicable for analog channels only. If set to 1, video mutes (blank screen) when no signal is present.

117 - FACT DEFAULT (Factory Default)

Set to 1 and press OK to restore the factory default settings of all Installer Menu items. Once complete, the value returns to 0.



Caution: If set to 1, this clears all Installer Menu custom settings and restores the factory default settings. It also clears the channel lineup, including any assigned channel icons and custom text labels.

Note: See also Reference section, "Restoring Factory Defaults on the TV(s)," for further information.

118 - POWER SAVINGS

Default set to 3—the power circuitry for both the embedded *b*-LAN module and the GAME CONTROL/MPI port is only powered when the TV is turned ON. When the TV is turned OFF, the embedded *b*-LAN and the GAME CONTROL/MPI port are not powered.

Note that the TV must be turned ON in order to communicate with the embedded *b*-LAN module for configuration and control when POWER SAVINGS is set to 3. If POWER SAVINGS is set to 1, the *b*-LAN module is always powered.

Similarly, if MPI communication is required for external MPI control, POWER SAVINGS should be set to 1 so that the GAME CONTROL/MPI port circuitry is always powered.

Note: See Reference section, "*b*-LAN Setup & Overview," for further information.



Caution: POWER SAVINGS should NEVER be set to 7. This setting is intended for factory use only.

119 - DATA CHANNEL

Set to 0 to disable. Set from 1 to 135 to match the (physical) RF channel number that will be used by the Pro:Centric server as its data channel.*

For TVs in Pass-through Mode or FTG Mode via CPU, if left at or set to (default value) 255, the TV's Data Channel Auto Search feature will be enabled. See additional information below.

Note: The Data Channel Auto Search feature is not available when the TV's EBL is in FTG Mode. If the DATA CHANNEL value is 255 when the TV is configured for FTG Mode via EBL, DATA CHANNEL is defaulted to 0.

* PCS150R and later Pro:Centric servers do not support HRC or IRC cable channel frequencies.

Data Channel Auto Search

When this item is set to 255 (default), once every 24 hours, the TV attempts to find an active Pro:Centric server.

- If connected to an IP network, the TV will first check for a “procentric.local” DNS entry. If the Pro:Centric server IP address is obtained from a DNS server, the DATA CHANNEL value will be changed from 255 to 253, which designates an IP data channel.

Note: The automated IP configuration feature requires a “procentric.local” DNS entry, which enables the Auto Search to obtain the Pro:Centric server’s IP address. This feature also expects the Pro:Centric server’s port number to be set to “80.”

- If an IP data channel is not found, the TV searches for an RF data channel. The TV will initiate a search of 10 predefined RF channels (10, 20, 30, ... 100) and then, if necessary, perform a complete search of the RF channels (1 to 135). If the Pro:Centric RF channel is found, the DATA CHANNEL value will be changed from 255 to match the server’s RF channel number.

The time at which the Auto Search occurs depends on the setting of item 121 UPDATE TIME HR. See item 121 description for further information.

Note: Pro:Centric updates are downloaded from the Pro:Centric server to the TV when the TV is turned OFF. While Pro:Centric updates are in progress, it is not possible to turn ON the TV.

Note: The Data Channel value also is automatically set to 253 if Media Type is set to “IP” either in the Solution Settings / EZ-Manager Wizard (see “Solution Settings / EZ-Manager Wizard” on pages 21 to 30) or in the IP Environment / Pro:Centric Menu (see “Pro:Centric Setup” on pages 63 to 65) on the TV or if Installer Menu item #119 Data Channel is set to “IP Address” or “IP Domain Name” in the Cloud Configuration Tool, which is typically used to configure TV CPUs for FTG Mode operation. It is not possible to change the value to “253” directly in the Installer Menu.

121 - UPDATE TIME HR

Based on the settings of this item and item 122 UPDATE TIME MN, the Wake For Update feature wakes the TV once daily to check for and, if applicable, download updates from the Pro:Centric server.

Set the Wake For Update hour from 0 to 23. This item uses the 24-hour clock format. The default value (128) is displayed as “DFT,” which means Default Time. Directly entering “128” resets the default value (Default Time) for this item. See additional information below.

Under standard TV OFF/ON operating conditions (i.e., item 002 AC ON is set to 0), a Wake For Update event occurs when the TV is OFF and causes the TV’s CPU to temporarily turn ON, perform the update cycle, and then turn back OFF, all while the TV appears to be OFF. If item 002 AC ON is set to 2, 3, 18, or 19 for Instant ON, then the TV’s CPU is always ON and Wake For Update occurs when the TV is in its Muted ON state (i.e., the TV only appears to be OFF). The Wake For Update event causes the TV’s CPU to reboot in order to perform the update cycle and then return to its Muted ON state. See also description for item 002.

Random Distribution of Update Time: If this item is set to 128 (Default Time), the time at which a Data Channel Auto Search (item 119 set to 255) and/or an Instant ON update (item 002 set to 2, 3, 18, or 19) occurs is determined as follows: Each TV initiates the search and/or checks for updates during the 2 AM hour (if the TV clock is set) or after two hours of elapsed time from when AC power was applied (if the TV clock is not set). Also, in this case, a fixed update time minute from 0 to 59 that has been assigned to each TV is used. (The intention of this feature is to prevent all of the installed TVs from performing updates at the same time; however, note that in installations that have a large quantity of TVs with this feature, there will be some TVs that have the same update minute assignments.) The update time for the TV is displayed at the right of this item in the Installer Menu, for example:

121 UPDATE TIME HR DFT [02:34]

If the TV display is ON when a Wake For Update event is to occur, the update will take place the next time the TV is turned OFF.



Caution: UPDATE TIME HR should NEVER be set to 255 (PREVENT). This setting is intended for factory use only.

Note: Brackets are only shown around the DFT (Default Time) setting. Any other time value for this item will not be shown with brackets.

Note: This item is not available in the Installer Menu when item 119 DATA CHANNEL is set to 0, except when item 002 AC ON is set to 2, 3, 18, or 19 for Instant ON. In addition, this item is not available in the Installer Menu when item 002 AC ON is set to 1, unless item 098 is not set to 0.

Note: The TV clock must be set in order for a Wake For Update event to occur at the precise time of day in accordance with item 121 and item 122 settings.

122 - UPDATE TIME MN

Set the Wake For Update minute from 0 to 59. If item 121 is NOT set to 128 and you wish to invoke the “random” minute assignment on the TV, set this item to 255. See also description for item 121 UPDATE TIME HR above.

Note: This item is not available in the Installer Menu unless item 121 UPDATE TIME HR is set from 0 to 23.

Note: The TV clock must be set in order for a Wake For Update event to occur at the precise time of day in accordance with item 121 and item 122 settings.

Custom Master TV Setup

This section describes how to create a customized Master TV Setup for cloning purposes when the TV is in Pass-through Mode. All cloning (export and import) processes on the TV are performed via USB memory device / “.tlx” file. The Master TV Setup may be exported to a Clone (.tlx) file, which can then be used (i.e., imported) to configure either TVs that are to remain in Pass-through Mode or TVs that are to be configured for FTG Mode via CPU.

Cloning requirements and procedures are described in detail on pages 49 to 54.

Note: You can also use the Cloud Configuration Tool to create an FTG Configuration (.tlx) file for FTG Mode via CPU configuration/cloning purposes, if desired (see pages 55 to 57). However, it is not possible to customize TV setup menu settings in the Cloud Configuration Tool. If you wish to include customized TV setup menu settings in the TV configuration, in addition to the channel lineup and Installer Menu settings, perform the Master TV Setup procedure to create a Clone (.tlx) configuration file.

Before You Begin

- It is recommended that you disconnect all Aux inputs if you intend to run Channel Tuning (Channel Search). Under certain conditions, Channel Tuning is disabled if there is an Aux input active.
- A Clone (.tlx) file comprises Installer Menu settings, IP Environment Menu settings (with the exception of unique TV attributes and settings), and all TV sources’ (analog, digital, AV, HDMI, etc.) clonable setup menu settings. See also “Clonable TV Setup Menu Features” list below.
- If the “.tlx” file (either a Clone or FTG Configuration file) to be imported on the Target TV(s) contains an FTG Channel Map, the Target TV(s) will be configured for FTG Mode via CPU, though as part of the import process, depending on the types of channels included in the Channel Map, you may have the option to select either logical or physical channel tuning. If you would like the Target TV(s) to remain in Pass-through Mode, the “.tlx” file should not include an FTG Channel Map.

Clonable TV Setup Menu Features

Picture Picture Mode Settings	Channels Channel Tuning Channel Manager Channel Label	Accessibility Audio Guidance Menu Transparency Closed Caption TV Power Sound High Contrast
Sound Sound Mode Settings Additional Settings – Volume Mode – AV Sync Adjustment	General Language Time & Date – Clock Mode (Auto/Manual) – Time Zone Timers (No Signal Power Off) Standby Light	

Note: Some menu options vary between analog and digital channels and Aux inputs.

Note: The Quick Settings Menu is initially displayed when you press **MENU SETTINGS** on the Installer Remote. Select the **All Settings**  menu icon to access the advanced TV setup menus. Several advanced settings are duplicated in the Quick Settings Menu.

Custom Master TV Setup Procedure

1. Turn ON the TV.

The next step depends on whether the First Use Wizard appears on the screen when you turn ON the TV:

- If the wizard is displayed, the TV is in the required factory default state. Exit the wizard, and then continue with step 2.
- If the wizard is not displayed, restore the TV to a factory default condition before continuing with this procedure. See Reference section, “Restoring Factory Defaults on the TV(s),” as necessary, for further information.

2. Set Installer Menu items.

This step provides specific instruction only on the Installer Menu items that should be set on a Master TV. Refer to pages 35 to 45 for detailed information on all Installer Menu items.

- Use the Installer Remote to access the Installer Menu (see “Accessing the Installer Menu” on page 35 for further information).
- Set Installer Menu item **003 BAND/AFC**, as appropriate.
 - Broadcast: Set to 0.
 - Cable: Set to 1 (default).
 - HRC: Set to 2.
 - IRC: Set to 3.
- Set any other Installer Menu items that affect your TV programming network to the required configuration. For example, enable/disable Aux inputs, set a Start Channel, etc.
- After you have adjusted all Installer Menu item settings as required, and if you do not need to configure any IP Environment settings (see note below), press **OK** once on the Installer Remote to save your changes; then, press **OK** again to exit the menu.

Note: If you intend to configure settings in the IP Environment Menu, which is accessible from the Installer Menu, you can proceed directly to step 3. All Installer Menu settings will be saved automatically when you access the IP Environment Menu.

3. Configure IP Environment settings.

Note: You cannot return directly to the Installer Menu from the IP Environment Menu; thus, you may wish to set all Installer Menu items as needed before you access the IP Environment Menu. Otherwise, you will need to reaccess the Installer Menu to set additional items.

Navigate to Installer Menu item 119 DATA CHANNEL, and press **2-5-3 + MENU SETTINGS** to launch the IP Environment Menu. Then, complete network configuration as required. See “IP Environment Setup” on pages 61 to 65 for further information.

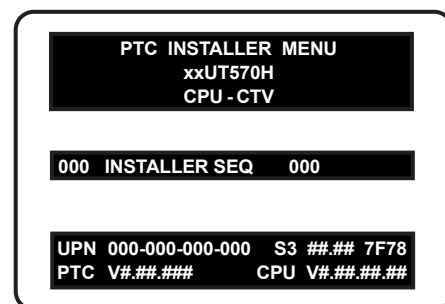

Typical Installer Menu



Adjust the value for this Installer Menu item, as required.

(Continued on next page)

Custom Master TV Setup (Cont.)

(Continued from previous page)

4. Set up TV features.

On-screen setup menus control the features of the TV. Press **MENU SETTINGS** on the Installer Remote, and select the **All Settings**  menu icon from the Quick Settings Menu to access the advanced TV setup menus. Then, set Picture, Sound, Channels, etc. options to the desired configurations. See “Clonable TV Setup Menu Features” list on page 46 and also notes below.

Note: If you intend to use the TV Zoning feature, make sure to set the appropriate TV Zone # at this time as described in Reference section, “Using the TV Zoning Feature.”

Note: If desired and if appropriate, you can run Channel Tuning (see step 5) prior to completing this step.

5. (Optional) Run Channel Tuning.

If you are creating a Master TV Setup for cloning purposes and you want the Target TV(s) to remain in Pass-through Mode or Application Tuning Mode, as applicable, do NOT run Channel Tuning. If you export a Master TV Setup that includes an auto-tuned/edited channel lineup, thereby creating a Clone (.tlx) file with an FTG Channel Map, and then import the Clone file to a Target TV, this will put the Target TV in FTG Mode via CPU.

Note: When you import a Clone/Configuration (.tlx) file that contains an FTG Channel Map on a Target TV (for FTG Mode via CPU configuration), depending on the types of channels included in the Channel Map, you may have the option to select either logical or physical channel tuning. For either selection, the channel sequence will be based on the order in which the channels appear in the FTG Channel Map. You can view and/or edit the channel sequence in the Cloud Configuration Tool, as required.

- a) Use the Installer Remote to access the Channels Menu. Then, select **Channel Tuning** and follow the on-screen instructions to search for all available digital and analog channels.
- b) Use the **Channel Manager** option in the Channels Menu to edit the channel lineup, as necessary. Add/delete channels per your system requirements.

6. Verify the TV setup.

Make sure the TV features are set per your requirements. Also, if applicable, verify that the channel lineup is correct.

The Master TV Setup is now ready to be saved (exported) to a USB memory device. See “Cloning Procedures” on pages 49 to 54.

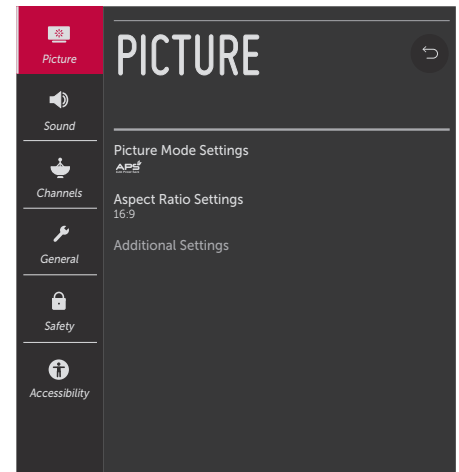

Use the TV setup menus to set the TV features to the desired configuration for the end user. This example illustrates the advanced TV setup menus.

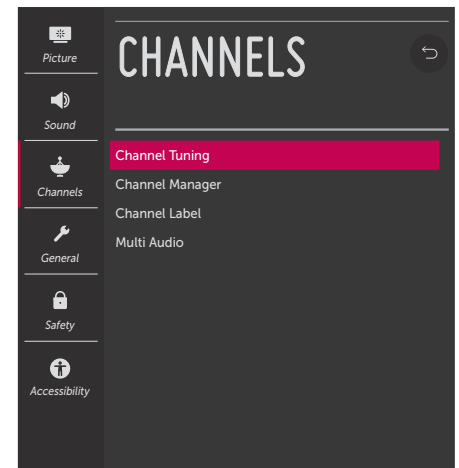

(Optional) Use Channels Menu options to run Channel Tuning and edit the channel lineup.

Cloning typically refers to the process of using a Master TV Setup to configure a Target TV. This section describes how to save (export) a Master TV Setup and then transfer (import) it to a Target TV using a USB memory device / Clone (.tlx) file.

You can also create an FTG Configuration (.tlx) file using the Cloud Configuration Tool and then use the Import Clone File procedure to transfer the configuration to Target TVs. Refer to “Creating an FTG Configuration File” on pages 55 to 57, as necessary.

Exporting a Clone File

This section describes how to use the TV Manager “Export Clone File” option to export Master TV Setup configuration to a USB memory device / Clone (.tlx) file.

Before You Begin

- Ensure the USB device has been formatted with FAT format.
- If applicable, complete the Custom Master TV Setup procedure (see pages 46 to 48).
- If you would like the Target TV(s) to remain in Pass-through Mode or Application Tuning Mode, as applicable, after the Clone file is imported, ensure the Master TV does not have an auto-tuned/edited channel lineup; otherwise, importing the exported file will result in the Target TV(s) being configured for FTG Mode via CPU.
- If you intend to use the TV Zoning feature, make sure to set the appropriate TV Zone # as described in Reference section, “Using the TV Zoning Feature,” BEFORE performing the procedure below.
- It is not possible to clone a Master TV’s clock. Either set a Target TV’s clock manually, or use the Auto Clock setting in the TV setup menus.
- Since the Export Clone File process retrieves the channel lineup from the CPU, if the TV is currently in FTG Mode via EBL (FTG Channel Map resides in EBL), it is not possible to export an FTG Channel Map.



Caution: Do not unplug the TV power cord or remove the USB memory device while exporting is in progress, as doing so may cause the TV to malfunction or harm the USB device, respectively.

Export Clone File Procedure

1. Ensure the Master TV is set up completely and turned ON.
2. Insert the USB memory device into the USB port on the Master TV.
3. Press **MENU SETTINGS** on the Installer Remote to display the TV setup menus (TV is in Pass-through Mode) or the Function Menu (TV is already in FTG Mode).
4. (TV in Pass-through Mode only) From the Quick Settings Menu displayed at the left of the screen, select the **All Settings**  menu icon and press **OK** to access the advanced TV setup menus.

(Continued on next page)

Cloning Procedures (Cont.)

(Continued from previous page)

5. Use the arrow navigation keys to select/highlight either the **General** menu icon from the TV setup menus or the **Safety** menu icon from the Function Menu. Then, press the number “7” key a total of seven times to access the TV Manager.

Note: Ez Download is always selected by default when you initially access the TV Manager. Also, note that Diagnostics is for service use only.

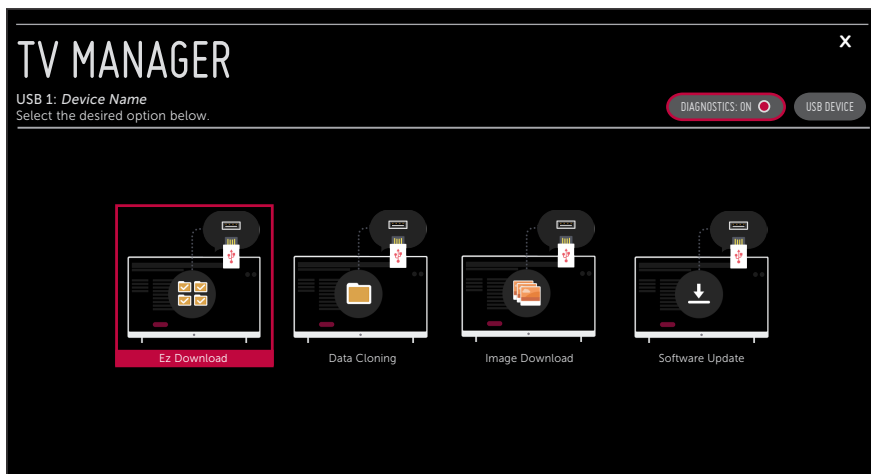

6. Use the arrow keys to select **Data Cloning**, and then press **OK**.
7. With the Data Cloning screen on display, key in the following number sequence on the Installer Remote: **9-8-7-6**. This will provide access to the “Export Clone File” option in the TV Manager (see example below).
8. Use the Up/Down arrow keys to select **Export Clone File**, and then press **OK**. Clone filename parameters will be displayed on the screen.

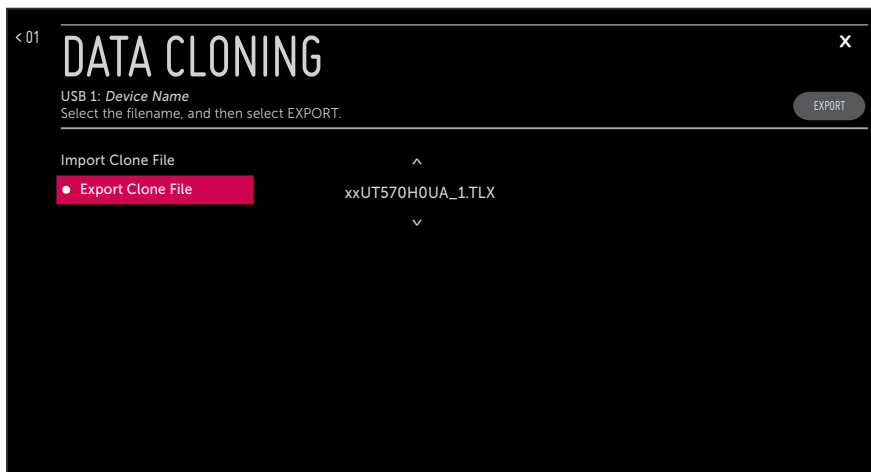

(Continued on next page)

(Continued from previous page)

9. Modify the filename, as required. While the TV model element of the filename may not be changed, you can differentiate this Clone file from other UT570H/UT577H Clone files by changing the numeric assignment appended to the end of the filename. Select/highlight the filename, and then use the Up/Down arrow keys on the Installer Remote to scroll through numeric assignments until the desired number is shown.
10. When you are ready to continue, i.e., when you have selected the desired filename, press **OK** on the Installer Remote to select/activate the **EXPORT** button at the top right of the screen, and then press **OK** on the Installer Remote once more to export the file.

Export progress will be displayed on the screen. This process may take a few minutes. Do NOT remove the USB device while exporting is in progress. When the export process is complete, an “Export Clone File is completed” pop-up message will be displayed on the screen.
11. Press **OK** to return to the TV Manager / Data Cloning screen. To return to program viewing, select the  button at the top right corner of the screen.
12. Remove the USB memory device from the Master TV.



Note: If the Master TV has a channel lineup, during the export process, logical channel numbers are automatically assigned in ascending order, starting with 0 (zero), to the physical RF channels of the TV channel lineup to create an FTG Channel Map. See also note below.



Note: If the exported Clone file is to be used for FTG Mode via CPU configuration (i.e., it contains an FTG Channel Map), it is highly recommended that you open the file in the Cloud Configuration Tool—BEFORE transferring (importing) the file to any Target TVs—to verify FTG Channel Map and FTG Installer Menu settings. This will also enable you to confirm channels and add channel attributes, labels, etc.

Importing a Clone File

This section describes how to transfer (import) a Clone or Configuration (.tlx) file from a USB memory device to a TV using the TV Manager “Import Clone File” option. The “.tlx” file may be created either from a Master TV Setup that was saved (exported) from a Master TV or in the Cloud Configuration Tool.

Before You Begin

- Ensure the USB device has been formatted with FAT format.
- Avoid using special characters, such as ?, &, @, etc., in the Clone/Configuration (.tlx) filename.
- If you have initiated the Solution Settings / EZ-Manager Wizard, you can use the wizard’s “USB Configuration” option to access the TV Manager and complete the import procedure (see “TV Configuration Options” and/or “USB Configuration” on pages 21 and 29, respectively, as necessary).
- You may also use the Ez Download utility to import the Clone/Configuration (.tlx) file. See “Ez Download Utility” on pages 31 to 34 for further information.

(Continued on next page)

Cloning Procedures (Cont.)

(Continued from previous page)

- If the Target TV is currently in Pass-through Mode and you intend to use the TV Zoning feature—i.e., the Clone/Configuration (.tlx) file you are importing contains an FTG Channel Map and/or FTG profile(s) with TV Zone assignments—make sure to set the appropriate TV Zone # in the TV when directed to do so in the procedure below. See Reference section, “Using the TV Zoning Feature,” for further information.
- If you would like the Target TV(s) to remain in Pass-through Mode or Application Tuning Mode, as applicable, after the Clone/Configuration (.tlx) file is imported, ensure the “.tlx” file does not contain an FTG Channel Map; otherwise, the import procedure will result in the Target TV(s) being configured for FTG Mode via CPU.
- If a Clone (.tlx) file (exported Master TV Setup) contains an FTG Channel Map, the physical RF channels in the FTG Channel Map have been assigned logical channel numbers (see “Exporting a Clone File” above). When you import the Clone file with the FTG Channel Map on the Target TV(s), you will have the option to select either logical or physical channel tuning. Even if you select physical channel tuning, the (list of) physical RF channels in the FTG Channel Map will remain in logical order.
- If an FTG Configuration (.tlx) file (created in the Cloud Configuration Tool) contains an FTG Channel Map, each logical channel number in the FTG Channel Map has been assigned a physical RF channel or an Aux input (the latter designated by 130-0 through 137-0—see also Reference section, “TV Aux Input Configuration”).

Note: When you import the FTG Configuration file on the Target TV(s), you will have the option to select either logical or physical channel tuning. If you select physical channel tuning, the physical RF channels and Aux inputs in the FTG Channel Map will remain in logical order.

- If the Target TV EBL is already in FTG Mode, you cannot use this procedure to make changes to the FTG Channel Map and FTG Installer Menu settings. You must use a direct PC-to-TV connection as described in Reference section, “FTG Mode via EBL (Local Configuration),” or an FMA head end device to reconfigure the EBL.
- If the preceding condition applies, but you wish to switch the TV to FTG Mode via CPU, see Reference section, “Restoring Factory Defaults on the TV(s),” for further information before proceeding.
- If the Clone/Configuration (.tlx) file was edited/created in the Cloud Configuration Tool, it may contain multiple zoned FTG Installer Menu profiles for different TV models. Make sure it includes the appropriate Installer Menu profile(s) for the Target TV(s) before performing the procedure below.

 **Caution: Do not unplug the TV power cord or remove the USB memory device while importing is in progress, as doing so may cause the TV to malfunction or harm the USB device, respectively.**

Import Clone File Procedure

1. Turn ON the Target TV.
2. The next step depends on whether the First Use Wizard appears on the screen when you turn ON the TV:

(Continued on next page)

(Continued from previous page)

- If the wizard is displayed, you can complete the import procedure via the Solution Settings / EZ-Manager Wizard, as indicated above (see “Before You Begin”). However, to continue with this procedure and access the “Import Clone File” option from the TV menus, exit the First Use Wizard. Then, continue with step 3.
 - If the wizard is not displayed, go directly to step 3.
3. If applicable (see also “Before You Begin” above), make sure to set the appropriate TV Zone # in the Target TV at this time.



Note: In order for the proper TV Zone profile data to be applied, the appropriate TV Zone # must be set in the Target TV BEFORE importing is initiated.

4. Insert the USB memory device with the Clone/Configuration (.tlx) file into the USB port on the Target TV.
5. Press **MENU SETTINGS** on the Installer Remote to display the TV setup menus (TV is in Pass-through Mode) or the Function Menu (TV is already in FTG Mode).
6. (TV in Pass-through Mode only) From the Quick Settings Menu displayed at the left of the screen, select the **All Settings**  menu icon and press **OK** to access the advanced TV setup menus.
7. Use the arrow navigation keys to select/highlight either the **General** menu icon from the TV setup menus or the **Safety** menu icon from the Function Menu. Then, press the number “7” key a total of seven times to access the TV Manager.

Note: Ez Download is always selected by default when you initially access the TV Manager. Also note that Diagnostics is for service use only.

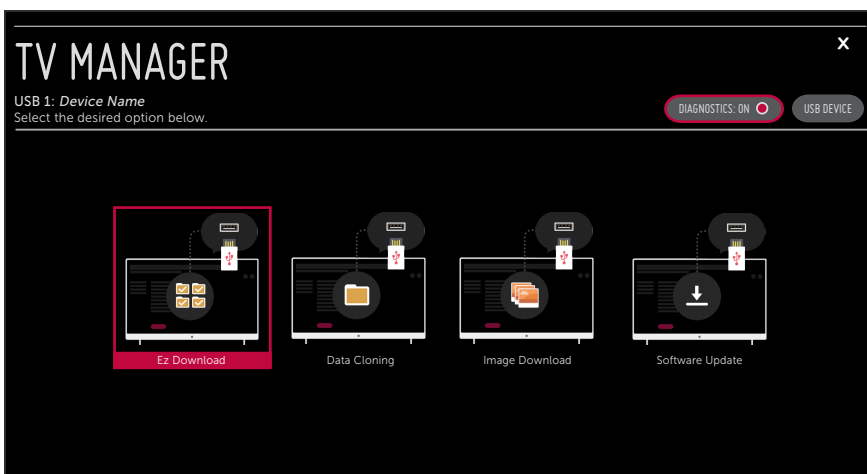

8. Use the arrow keys to select **Data Cloning**, and then press **OK**.

When the Data Cloning screen is initially displayed, the “Import Clone File” option is selected by default, and a list of the “.tlx” files stored in the root folder of the USB memory device is displayed on the screen.

(Continued on next page)

Cloning Procedures (Cont.)

(Continued from previous page)

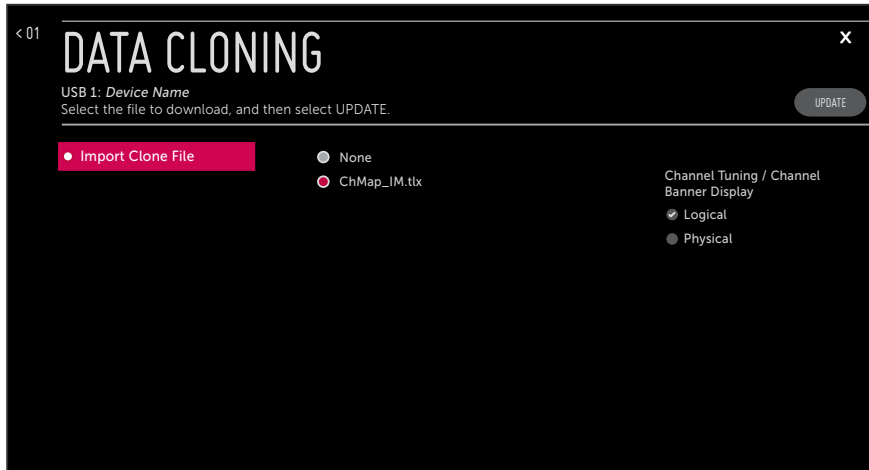

9. Use the arrow keys on the Installer Remote to select/highlight the “.tlx” file to import, and then press **OK**.

Note: Filenames of exported Clone files are comprised of the TV model and a numeric element, for example, xxUT570H0UA_1.TLX.

10. If the Clone/Configuration (.tlx) file includes an FTG Channel Map, you can choose the format for the channel tuning/banner display. Use the arrow keys to select the desired Channel Tuning / Channel Banner Display option—either Logical or Physical—at the right side of the screen. A checkmark will appear at the left of the selected option. Logical tuning is selected by default.

Note: If the “.tlx” file does not include an FTG Channel Map, the message, “No Channel Map in Clone file,” will be displayed at the right of the screen.

11. When you are ready to continue, select **UPDATE** on the screen and then press **OK** on the Installer Remote.

Import progress will be displayed on the screen. This process may take a few minutes. Do NOT remove the USB device while importing is in progress. When the import process is complete, an “Import Clone File is completed” pop-up message will briefly be displayed on the screen, and then, the TV will reboot.

12. Remove the USB memory device from the Target TV, and verify that the appropriate configuration is now resident on the Target TV.

Note: If the Target TV was previously in Pass-through Mode, and the Clone/Configuration (.tlx) file that was imported contained an FTG Channel Map, the Target TV CPU is now in FTG Mode. Upon restart, the TV tunes according to the Start Channel setting in the Installer Menu. If a Start Channel is specified, the TV will tune to that channel, though, in the case of FTG Mode via CPU configuration, a channel banner will only be displayed if the Start Channel is included in the FTG Channel Map (depending on your selection in step 10, the channel banner will display either the Start Channel’s logical channel number or physical RF channel number). Otherwise, the TV will either return to the last channel tuned (TV in Pass-through Mode) or tune to the first channel in the FTG Channel Map (TV in FTG Mode via CPU). If the latter, remember that the channels in the FTG Channel Map are always arranged in logical order, regardless of your selection in step 10.

As indicated in the introduction to this document, there are two separate and distinct methods for configuring UT570H/UT577H TVs for FTG Mode of operation: one method is to configure the TV CPU for FTG Mode operation, while the other is to configure the TV EBL for FTG Mode operation. FROM A LOCAL CONFIGURATION STANDPOINT, EACH OF THESE METHODS IS MUTUALLY EXCLUSIVE. IF THE CPU IS IN FTG MODE, THE EBL CANNOT BE SWITCHED TO FTG MODE. LIKEWISE, IF THE EBL IS IN FTG MODE, THE CPU CANNOT BE SWITCHED TO FTG MODE.

This section provides an overview of LG's Cloud Configuration Tool web application, which is used for FTG Mode via CPU configuration. For best results, it is recommended that you access the Cloud Configuration Tool using one of the following web browsers: Google Chrome™ 51 or later or Mozilla Firefox® 47 or later.

Creating an FTG Configuration File

The subsections below briefly describe how to use the Cloud Configuration Tool to create an FTG Configuration (.tx) file that can be used to configure the TV for FTG Mode via CPU. The Cloud Configuration Tool provides options both for advanced and new users. If you are not familiar with the steps to create an FTG Configuration file, you may choose a Wizard Setup that will guide you through the process of creating a new file. Refer to the **Cloud Configuration Tool User Guide** for further information.

Note: There is also an option to save (export) configuration from a TV, which may be desirable or required if you want to save customized TV setup menu settings to the FTG Configuration file and/or if you do not know the RF channels at the site. See "Exporting a Clone File" on pages 49 to 51 for further information.

Access the Cloud Configuration Tool and Select a Setup Option

1. Launch a web browser, and navigate to the following URL: **cct.procentric.tv**.
2. On the Welcome web page, make sure **North America** (default) is selected in the Select Your Region field, and then click on the **SELECT** button at the right of the field.

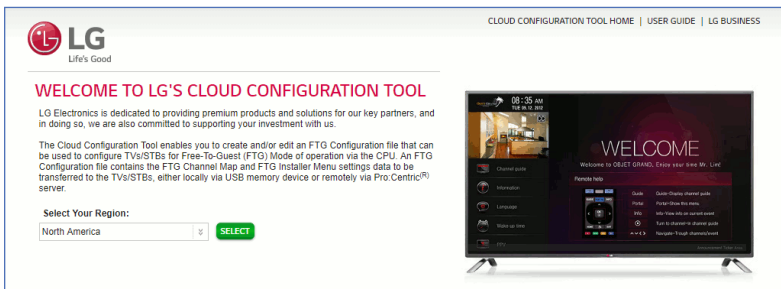

3. Once you select your region, you can choose the desired setup option, depending on your familiarity with the utilities and/or your file requirements:

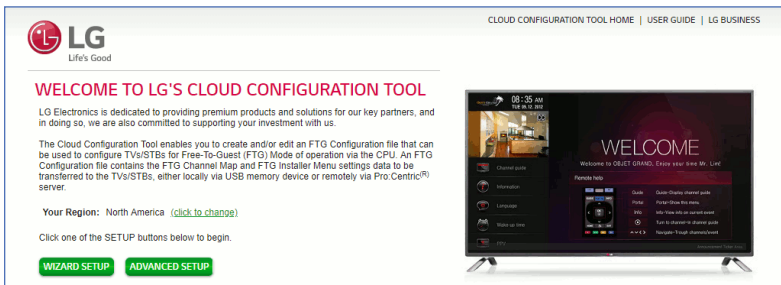

(Continued on next page)

Cloud Configuration Tool Overview (Cont.)

(Continued from previous page)

- If you are creating an FTG Configuration file from scratch and this is your first time using the Cloud Configuration Tool, you may wish to select the Wizard Setup, which will guide you through the essential steps of creating the file, i.e., creating the FTG Channel Map and/or the Installer Menu profile(s). To initiate the Wizard Setup, click on the **WIZARD SETUP** button.

On the next wizard page you will be prompted to indicate whether you would like to create an FTG Channel Map. Note that an FTG Channel Map is required for FTG Mode operation. Once you complete (or bypass) Channel Map activities and proceed to the next step, you will be prompted to indicate whether you would like to create an Installer Menu profile. The final wizard step enables you to review a summary of the FTG Configuration (.tlx) file contents and then save (export) the file to your PC.

- To view and/or base a new FTG Configuration file on an existing FTG Configuration (.tlx) file, or if you do not require wizard guidance to complete your activities, click on the **ADVANCED SETUP** button.

The File Manager web page will be displayed, and you have a number of options.

The following procedure provides an overview of the Advanced Setup. Refer to the **Cloud Configuration Tool User Guide** for further information on both the Wizard Setup and the Advanced Setup.

Advanced Setup Overview

1. When you select **ADVANCED SETUP** from the Welcome page (see “Access the Cloud Configuration Tool and Select a Setup Option” above), the File Manager page is displayed (see example on page 58).
2. (Optional) If desired/appropriate, you may view and/or base the new FTG Configuration file on an existing FTG Configuration (.tlx) file:

- Click on the **BROWSE** button at the right of the Find File to Upload field, and select/double-click on the desired “.tlx” file. Then, click on the **UPLOAD** button below the Find File to Upload field.

Once the file is successfully uploaded, the Find File to Upload field is replaced with a Loaded From File summary of the file’s contents, including a Channel Map Summary, Installer Menu Summary, and Setup Menu Summary.

- Double-click on each item in the Loaded From File summary at the left of the page that you would like to copy to the FTG Configuration List at the right of the page. As you move your mouse over the contents of a summary field, the field will be highlighted in blue, and  arrows at the right of the field will indicate that the data may be copied to the FTG Configuration List.
- Edit the configuration of the items in the FTG Configuration List as well as the FTG Configuration List itself, as necessary, to create a new file.

Note: While Setup Menu profiles can be included in the new FTG Configuration file (i.e., the profile[s] can be copied to the FTG Configuration List), Setup Menu profiles are not available for editing. However, on the File Manager page, you may change the Zone assignment for a Setup Menu profile, as required, for those models on which the TV Zoning feature is supported.

Note: If desired, you can click on the **UPLOAD NEW FILE** button below the list of Loaded From File items to select a different existing FTG Configuration file. If you want to add Installer Menu and/or Setup Menu profiles from more than one existing file to the new FTG Configuration file, make sure to transfer the appropriate items from the currently uploaded file to the FTG Configuration List before uploading a different file.

(Continued on next page)

Cloud Configuration Tool Overview (Cont.)

(Continued from previous page)

3. If you need to edit the FTG Channel Map from an existing file (see previous step) or create a new FTG Channel Map, click on **CHANNEL MAP** in the menu options bar at the top left of the page to access the Channel Map web page (see example on page 59), and edit/create the FTG Channel Map. Up to 600 logical channels can be defined in the FTG Channel Map.

4. (Optional) To load default FTG Installer Menu settings by model, click on **INSTALLER MENU** in the menu options bar at the top left of the page to access the Installer Menu web page (see example on page 60), select the desired model/chassis ID and the desired Zone, and then click on the **CREATE PROFILE** button to create a new profile.

The new model profile will be added to the Installer Menu Profile List at the top right of the page, and the Installer Menu items for the selected model will now be displayed on the lower half of the page. The Summary tab shows the features that are available for configuration. Click on any Installer Menu item in the Summary tab or a category tab (User, Tuning, Audio, etc.) to view and/or edit its parameters, as required.

Note: Unless you select a different Zone assignment when you create the new profile, the default Zone 0 is assigned automatically. See Reference section, “Using the TV Zoning Feature,” for further information on the TV Zoning feature and setting the TV Zone # in the TV(s).

5. Click on **FILE MANAGER** in the menu options bar at the top left of the page to return to the File Manager web page. The FTG Configuration List will now be populated with summaries of the FTG Channel Map, FTG Installer Menu profile(s), and, if applicable, Setup Menu profile(s) you created or added in the previous steps. Review and edit the FTG Configuration List, as necessary.

Note: If you need to edit the Channel Map or an Installer Menu profile, double-click on the desired item to access the Channel Map page or the Installer Menu page, as applicable. When you return to the File Manager page, the FTG Configuration List is automatically updated with all Channel Map and Installer Menu changes. (Installer Menu and/or Setup Menu profile Zone assignments may be changed on the File Manager page.)

Note: To remove an individual item from the FTG Configuration List, click on the **X** at the right of the applicable item. At the prompt for confirmation , either click **yes** to confirm and remove the item immediately, or click **no** to retain the item. To clear all current FTG Configuration List contents, click on the **CLEAR LIST** button at the bottom right of the FTG Configuration List.

6. Export the FTG Configuration List contents to an FTG Configuration (.tlx) file on the PC's hard drive for later use:
 - Type a brief descriptive name in the File Name field at the bottom of the FTG Configuration List (avoid using special characters, such as ?, &, @, etc.).
 - Click on **EXPORT FILE**.
 - In the Save As window (if applicable—see note below), select the desired location to which to export the file (you can also edit the file name here, if necessary), and click **Save**.

Note: Depending on the browser you are using and its current settings, files may automatically be saved to the “Downloads” or another designated folder on your PC. If you want to be able to select the folder in which to save the FTG Configuration file, check your browser settings.

7. Transfer the FTG Configuration (.tlx) file to a USB memory device, and proceed to “Importing a Clone File” on pages 51 to 54 to transfer the FTG Configuration file to a UT570H/UT577H TV.

Cloud Configuration Tool Overview (Cont.)

File Manager Web Page Overview

The File Manager page (displayed after you select ADVANCED SETUP from the Welcome page) enables you to compile, modify, and save (export) FTG Configuration (.tlx) files. The following example provides an overview reference of the functions available on the File Manager page.

Data contained in uploaded FTG Configuration (.tlx) file. Users may choose to copy some or all of this data to the FTG Configuration List.

Data to be saved in the FTG Configuration (.tlx) file. This data may include contents transferred from an uploaded file and/or Channel Map/ Installer Menu contents created or modified in the Cloud Configuration Tool.

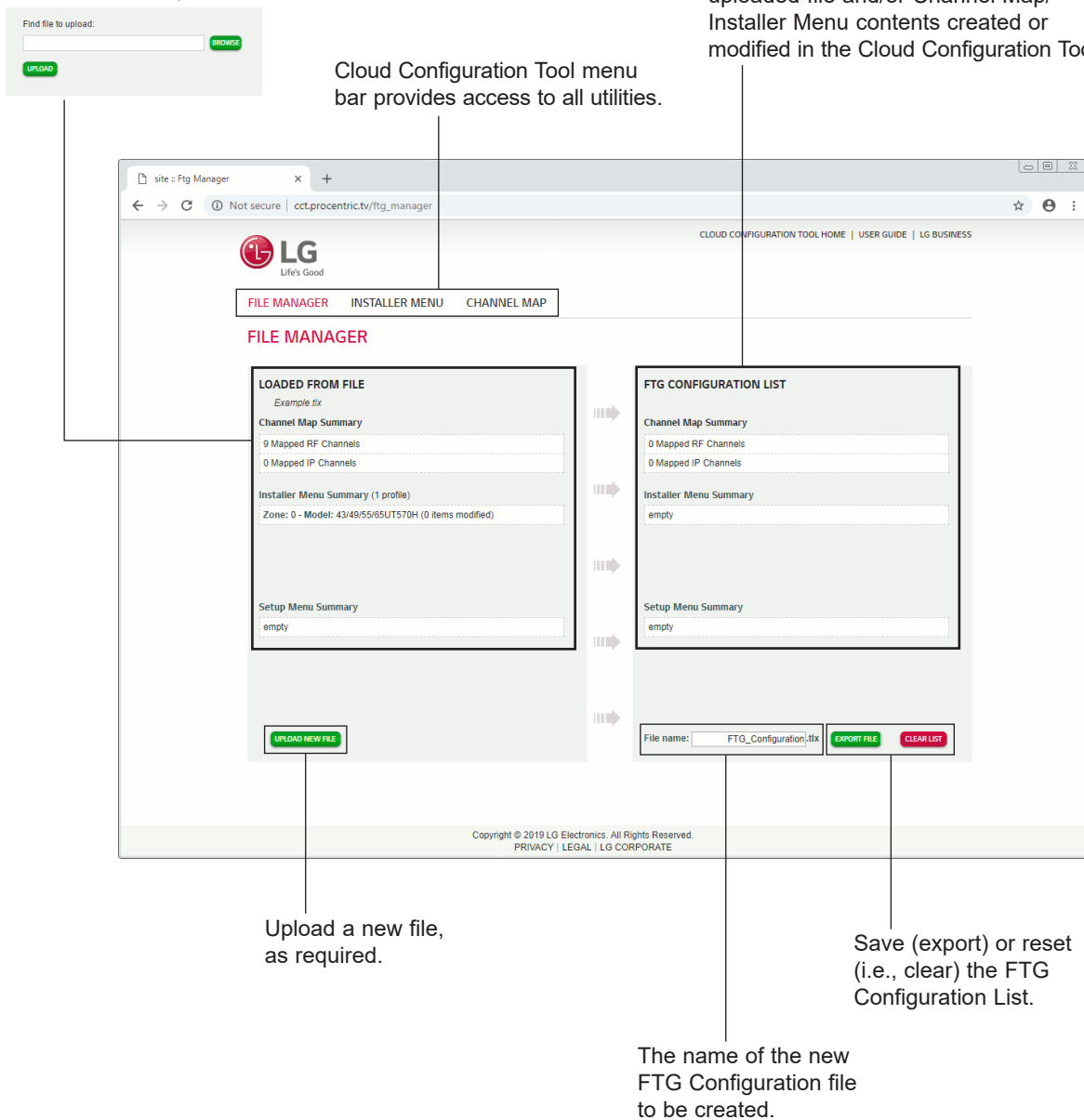

Cloud Configuration Tool Overview (Cont.)

Channel Map Web Page Overview

On the Channel Map page, you can create, view, and edit a Logical Channel Map.

Search for existing channels or clear the FTG Channel Map.

(Advanced Setup only) Cloud Configuration Tool menu bar provides access to all utilities.

Click the RF CHANNEL button to add a new RF channel to the FTG Channel Map.

(Wizard Setup only) Proceed to next step.

The screenshot shows the 'CHANNEL MAP' web page. At the top, there is a navigation bar with 'FILE MANAGER', 'INSTALLER MENU', and 'CHANNEL MAP'. Below this is a search bar labeled 'CHANNEL MAP SEARCH (enter Logical or Label)' with a 'CLEAR CHANNEL MAP' button. To the right, there are buttons for 'RF CHANNEL' and 'IP CHANNEL', and a 'NEXT STEP' button. The main content is a table with the following columns: Logical, Channel Icon, Label, RF IP Address, Major, Minor, PLP ID, IP Type, IP Port, Prog #, Source Address, Attribute, Restricted from Zones, and Actions. The table lists several channels including CBS, NBC, CNN, ABC, PBS, History, and Discovery. Each row has edit and delete icons in the Actions column.

Click the appropriate icon to either edit an existing Logical Channel's data (see below) or remove a channel from the FTG Channel Map.

This section provides a detailed view of the channel configuration form. It includes the following annotations:

- Select a channel icon (select "No Logo" if applicable), and/or enter a custom channel label.** - Points to the 'Channel Icon' dropdown and the 'Label' input field.
- Assign the RF, Major, and Minor channel numbers and PLP ID for the channel.** - Points to the 'RF IP Address', 'Major', 'Minor', and 'PLP ID' input fields.
- Set Zone restriction(s) per channel. Zones you select will be listed in the Restricted from Zones column. See Reference section, "Using the TV Zoning Feature," for further information.** - Points to the 'Restricted from Zones' section with checkboxes for Zone 1 through Zone 8.
- Enter a logical channel number.** - Points to the 'Logical' input field.
- Set channel attributes. Check/select Encrypted, OSD, or Blank Video.** - Points to the 'Attribute' section with checkboxes for Encrypted, OSD, and Blank Video.
- After adding a new channel or editing an existing channel, save or cancel the changes.** - Points to the 'SAVE' and 'CANCEL' buttons.

Cloud Configuration Tool Overview (Cont.)

Installer Menu Web Page Overview

(Advanced Setup only) Cloud Configuration Tool menu bar provides access to all utilities.

Load default Installer Menu for selected model. Assign Zone as applicable. Once you click on CREATE PROFILE, this Installer Menu profile will be listed under the Installer Menu Profile List, and Installer Menu items will be displayed on the lower half of the page.

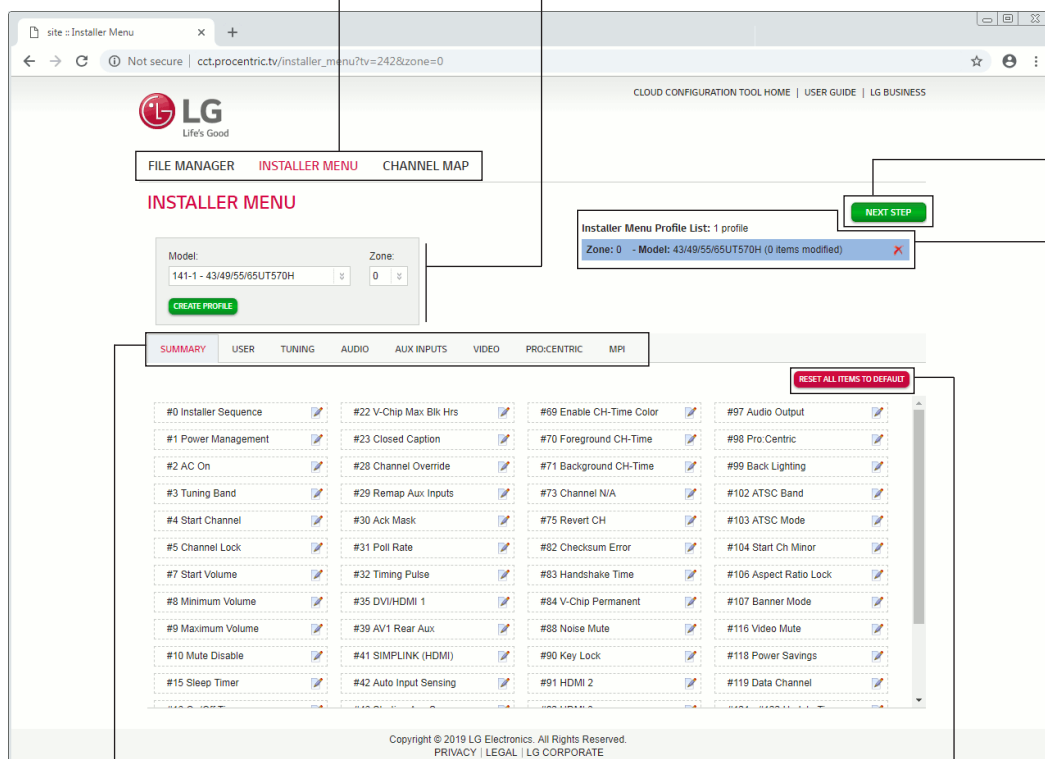

(Wizard Setup only) Proceed to next step.

Installer Menu profiles to be included in the FTG Configuration (.tlx) file. The currently active profile is highlighted.

Select tabs for categories of Installer Menu items to set up TV.

Reset default values for currently active configuration profile. A RESET button is also available within each category tab.

Note: The Pro:Centric tab enables you to set up Pro:Centric-specific parameters. Refer to the *Cloud Configuration Tool User Guide* for further information.

The IP Environment Menu enables you to set up the network features of the TV. If you intend to create a Master TV Setup for cloning purposes (see Master TV Setup procedure on pages 46 to 48), all IP Environment settings, with the exception of network settings, may be cloned.

Note: With the exception of network settings, IP Environment settings are editable (with the Installer Remote) only if the TV is in Pass-through Mode and read-only if the TV is not in Pass-through Mode.

Accessing the IP Environment Menu

The IP Environment Menu is accessible from the First Use Wizard or from the Installer Menu. For information on accessing the IP Environment Menu from the First Use Wizard, see “First Use Wizard” on pages 17 to 18. The steps below describe how to access the IP Environment Menu from the Installer Menu.

Note: When you enter the IP Environment Menu, the Installer Menu is exited (all current settings are saved automatically upon exit). If you are also in the process of updating Installer Menu items, you may wish to set all items as needed before you access the IP Environment Menu. Otherwise, after exiting the IP Environment Menu, you will need to reaccess the Installer Menu to set additional items.

1. Use the Installer Remote to access the Installer Menu (see “Accessing the Installer Menu” on page 35 for further information).
2. Navigate to Installer Menu item 119 DATA CHANNEL, and press **2-5-3 + MENU SETTINGS** to launch the IP Environment Menu.

Use the Up/Down arrow keys on the Installer Remote to select the desired menu option and then press **OK**. Refer to the following sections for information on each of the IP Environment setup options.

When you have completed your IP Environment configuration as required, press **EXIT** or **↶** on the Installer Remote to exit the IP Environment Menu.

Network Configuration

This section describes how to configure a wired network connection.

1. With the IP Environment Menu on display, use the arrow keys on the Installer Remote to select the **Network** menu option. Then, press **OK**.

Note: The TV’s MAC address is displayed at the top of the Network Menu screen and cannot be modified.

2. Connect the appropriate cable between the TV and the network.
3. With the Network Menu on display, use the arrow keys on the Installer Remote to select **Network Settings**. Then, press **OK**. A Network Settings screen (see example on following page) will be displayed.

By default, the TV uses DHCP, and if a Local Area Network (LAN) is detected, the TV will request an IP address from the DHCP server on the network as soon as you select “Network Settings.” If the TV is able to connect to the network, a “Connected to Internet” message will appear below the Wired Connection (Ethernet) field.

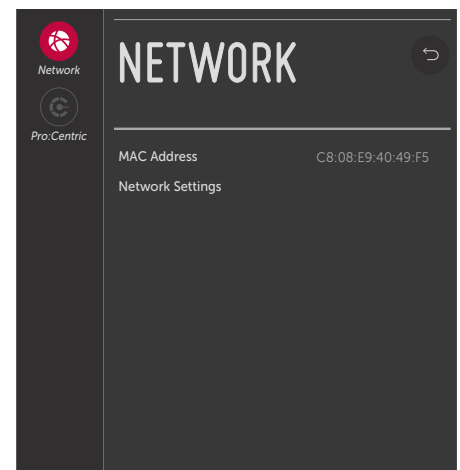

(Continued on next page)

IP Environment Setup (Cont.)

(Continued from previous page)

4. If the network is not configured for DHCP, or if you want to enable/disable IPv6, specify static IP configuration data, or change the network configuration from Manual to Automatic, select **Wired Connection (Ethernet)** and press **OK**.

In the Wired Connection (Ethernet) screen, you can change the IPv6 status and/or edit the IP data for this TV.

5. To enable/disable IPv6, select/highlight the IPv6 field and press **OK**. Then, select **Enabled** or **Disabled** from the drop-down list of options, as applicable.
6. To edit/specify static IP data or change the network configuration from Manual to Automatic, use the arrow keys on the Installer Remote to select **Edit** at the bottom of the screen and press **OK**. Then, in the Edit screen:

- Select or de-select the “Set Automatically” checkbox, as required. A checkmark indicates that Automatic configuration is enabled.
 - To manually edit the IP data, for each data entry field: Use the arrow keys on the Installer Remote to select the field and press **OK**. You can use the number keys on the Installer Remote to direct enter numeric values or use the arrow keys to select the appropriate alphanumeric characters (as applicable) from the pop-up virtual keyboard displayed at the bottom of the screen. When you are done, select **Enter** from the virtual keyboard, and then press **OK** on the Installer Remote.
- Note:** For IPv4, you must use the dot “.” key from the virtual keyboard to separate each octet of an IP address. For IPv6, you must use the colon “:” key from the virtual keyboard to separate each group of an IP address.
- When all Edit fields are set as required, use the arrow keys on the Installer Remote to select **Connect** and press **OK**.

At the top of the screen, you will see a progress display that indicates status as each network element is confirmed.

If the network is connected successfully, a “Connected to Internet” message will appear just below the progress display. If the network connection is not successful, the progress display will identify the network element in which the connection failed. Check your cabling and/or verify the configuration data, as necessary.

7. Once the wired network configuration is complete, use the arrow keys on the Installer Remote to return to the IP Environment Menu, as necessary, or press **↩** to return to the previous Network Menu level(s) and/or exit the IP Environment Menu.

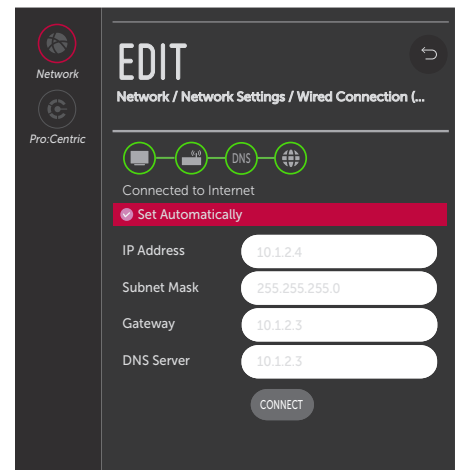
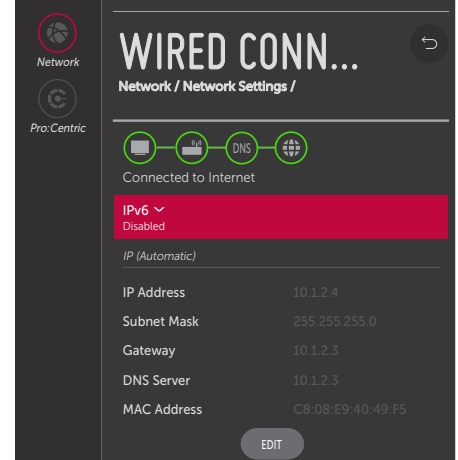
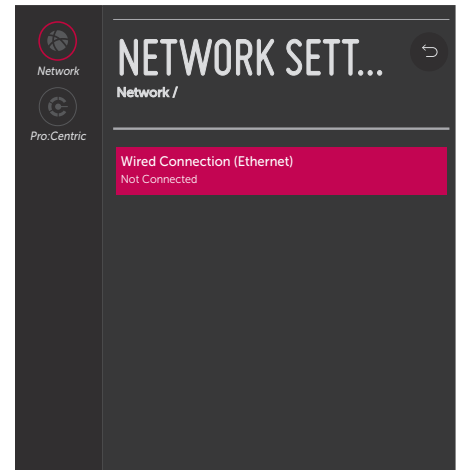

Pro:Centric Setup

Pro:Centric options enable you to configure the TV with the appropriate settings to connect to the Pro:Centric server. Use the Up/Down arrow keys on the Installer Remote to navigate between fields.

1. With the IP Environment Menu on display, use the arrow keys on the Installer Remote to select the **Pro:Centric** menu option. Then, press **OK**.
2. Select/highlight the **Media Type** field and press **OK** on the Installer Remote to display the drop-down list of options. Then, use the Up/Down arrow keys to select either **RF** or **IP**, as applicable.

Note: If the Media Type has already been set in the Solution Settings / EZ-Manager Wizard, the specified value will be reflected in this field.

3. Refer to the appropriate subsection(s) below to configure the TV's Pro:Centric settings to match those of the Pro:Centric server.

While the Pro:Centric application itself is an additional feature (see step 4), the appropriate Pro:Centric server configuration must be completed to enable TV E-Z Installation (boot logo, configuration, and software) data downloads and, if configured, the Pro:Centric application download.

RF Configuration

For TVs in Pass-through Mode or FTG Mode via CPU, if the Data Channel is left at its default value (AUTO), the TV's Data Channel Auto Search feature will be enabled. See Installer Menu item 119 DATA CHANNEL description on page 44 for further information.

- To change the Data Channel setting, select/highlight the **Data Channel** field and press **OK** on the Installer Remote. Then, use the Up/Down arrow keys to select either **MANUAL** or **AUTO** from the drop-down list of options.
- When the Data Channel field is set to "MANUAL," a data entry field is available on the screen, and you can specify the RF channel number that will be used by the Pro:Centric server as its data channel. The Data Channel value can be set from 0 (disabled) to 135.*

Use the arrow keys on the Installer Remote to select the Data Channel data entry field and press **OK**. You can then use the number keys on the Installer Remote to direct enter the Data Channel, or you can use the arrow keys to select the appropriate number(s) from the pop-up virtual keyboard displayed at the bottom of the screen. When you are done, select **Enter** from the virtual keyboard, and then press **OK** on the Installer Remote.

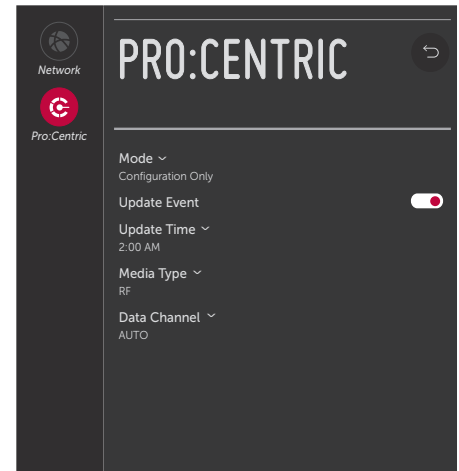

Note: By default, the Pro:Centric Menu initially shows RF configuration fields. When "IP" is selected as the Media Type, Server Address, IP Type, IP Address, and Port Number fields appear on the screen (in place of the Data Channel field).

(Continued on next page)

* PCS150R and later Pro:Centric servers do not support HRC or IRC cable channel frequencies.

IP Environment Setup (Cont.)

(Continued from previous page)

Note: If the Data Channel has already been set in the Installer Menu (item 119) or in the Solution Settings / EZ-Manager Wizard, the specified channel will appear in the Data Channel data entry field. If you change the Data Channel in this menu, Installer Menu item 119 will now show the value you entered here.

IP Configuration

Note: If the server IP address and port number or domain name have already been set in the Solution Settings / EZ-Manager Wizard, the specified data will be reflected in the fields displayed.

Note: Setting the Media Type to “IP” automatically sets item 119 DATA CHANNEL in the Installer Menu to 253. You cannot alter this setting unless you revert Media Type to “RF.” Also, it is not possible to direct enter “253” in the Installer Menu.

- a) The Server Address field provides the option to specify the domain name of the Pro:Centric server instead of the server’s IP address. Select/highlight the **Server Address** field and press **OK** on the Installer Remote. Then, use the Up/Down arrow keys to select either **IP Address** or **Domain Name** from the drop-down list of options for defining the server.
- b) Depending on your selection in the previous step, either:
 - Select the appropriate IP type (either IPv4 or IPv6) in the IP Type field, and then enter the Pro:Centric server IP address in the IP Address field. The IP address must match the IPv4 or IPv6 (as applicable) address that is set in the Pro:Centric server.
 - Enter the Pro:Centric server domain name in the Domain Name field. Note that in order for the domain name to be resolved to an IP address, there must be a DNS entry for the domain name.

For each data entry field: Use the arrow keys to select the field and press **OK**. Then, you can either use the number keys on the Installer Remote to direct enter data values, or you can use the arrow keys to select the appropriate number(s)/alphanumeric character(s) from the pop-up virtual keyboard displayed at the bottom of the screen. When you are done, select **Enter** from the virtual keyboard, and then press **OK** on the Installer Remote.

- c) Enter the Pro:Centric server port number in the Port Number field. The port number must match the port number that is set in the Pro:Centric server.
4. Select/highlight the **Mode** field and press **OK** on the Installer Remote to display the drop-down list of options. Then, use the Up/Down arrow keys to select the appropriate Pro:Centric Application Mode setting—**Configuration Only**, **GEM** (Java), or **HTML**. If the Pro:Centric Application Mode is set to “Configuration Only,” Pro:Centric application data will not be downloaded.

Note: If the mode has already been set in the Installer Menu (item 098 PRO:CENTRIC) or in the Solution Settings / EZ-Manager Wizard, the specified mode will be reflected in this field. If you change the mode in this menu, Installer Menu item 098 will now reflect the value you selected here.
 5. Select/specify the appropriate Update Event setting(s), as required. Based on Update Time settings, the Wake For Update feature wakes the TV once daily to check for, and if applicable, download updates from the Pro:Centric server. See Installer Menu item 121 UPDATE TIME HR description on page 45 for additional information on Wake For Update functionality.

(Continued on next page)

(Continued from previous page)

- Select/highlight the **Update Event** field and press **OK** on the Installer Remote to toggle the setting as required. When Update Event is enabled, an Update Time field is displayed on the screen.
 - If Update Event is enabled, set the Update Time as required. Use the arrow keys on the Installer Remote to select/highlight the **Update Time** field, and then press **OK**. Hour, Minute, and Meridiem fields will be displayed. Select each field in turn and specify the appropriate Wake For Update time, as desired. Note that the Update Time set in this menu is based on a 12-hour clock. Ensure the meridiem (AM/PM) specification is set accordingly.
6. Once all fields are completed as required, use the arrow keys on the Installer Remote to return to the IP Environment Menu, as necessary, or press ↵ to exit the IP Environment Menu.

Reference: Remote Jack Pack / TV Connections & Setup

Remote Jack Pack Setup

RJP Available? If you will use a Remote Jack Pack (RJP) in your system, set Installer Menu item **093 RJP AVAILABLE** appropriately (for example, on a legacy model RJP: HDMI Mode, set RJP AVAILABLE to 1). See Installer Menu detailed descriptions for further information.

093 RJP AVAILABLE 001

TV Connections

Caution: Make these connections **ONLY** after Master TV Setup and TV cloning procedures are complete. Also, make sure to use the RJ45 Control cable from the RJP cable bundle to make the connection to the TV's RJP port. Do **NOT** connect a standard Ethernet cable to the RJP port, as this may damage the TV and network equipment.

Refer to the figure below, and connect the RJ45 Control cable from the RJP cable bundle to the RJP port on the TV's rear jack panel. Then, connect HDMI, and Composite Video/Audio connectors, as applicable, for the cable bundle.

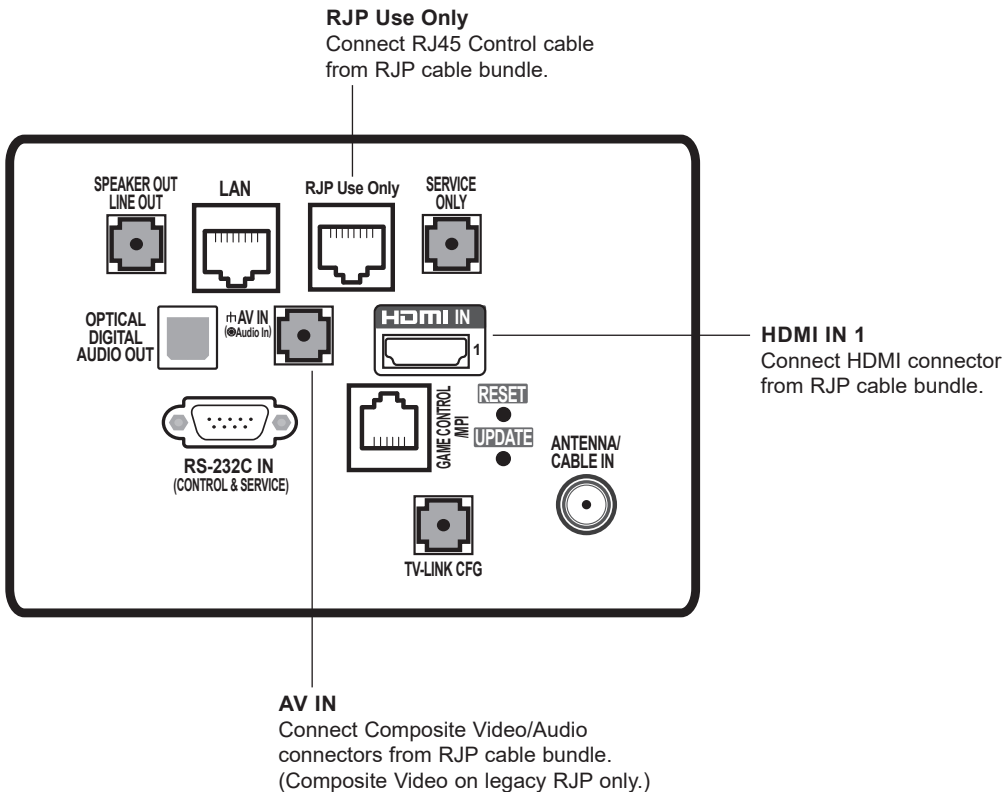

Note: RGB is not supported on these TV models. If an RGB source is connected to a legacy RJP, you will see a brief message on-screen to indicate that this device is not supported.

Reference: Updating TV/PTC Software using a USB Memory Device

This section describes how to update TV (CPU) and/or PTC software using the TV Manager “Update TV Software” and/or “Update PTC Software” option(s), respectively, though you may also use the Ez Download utility to update software, if desired. See “Ez Download Utility” on pages 31 to 34 for further information.

Before You Begin

- Software update files must be stored in a folder named “LG_DTV” in the root directory of the USB memory device.
- Ensure the USB device has been formatted with FAT format.

Update the TV/PTC Software

Note: You can check the TV/PTC software versions by accessing the Installer Menu with the Installer Remote. See “Accessing the Installer Menu” on page 35 for further information. PTC and CPU versions are displayed in the Installer Menu footer.

Note for TV CPU Software Update only: If the TV detects a software file on the USB device, it will automatically display an Update TV Software screen, and if the file contains a later version of software than is currently running on the TV, you can start the software update from this screen (select **UPDATE** and press **OK**). Otherwise, you can exit the screen (select **CANCEL** and press **OK**), and access the TV Manager as described below.

1. Turn ON the TV, and then insert the USB memory device into the TV’s USB port.
2. Press **MENU SETTINGS** on the Installer Remote to display the TV setup menus (TV is in Pass-through Mode) or the Function Menu (TV is not in Pass-through Mode).
3. (TV in Pass-through Mode only) From the Quick Settings Menu displayed at the left of the screen, select the **All Settings**  menu icon and press **OK** to access the advanced TV setup menus.
4. Use the arrow navigation keys to select/highlight either the **General** menu icon from the TV setup menus or the **Safety** menu icon from the Function Menu. Then, press the number “7” key a total of seven times to access the TV Manager.

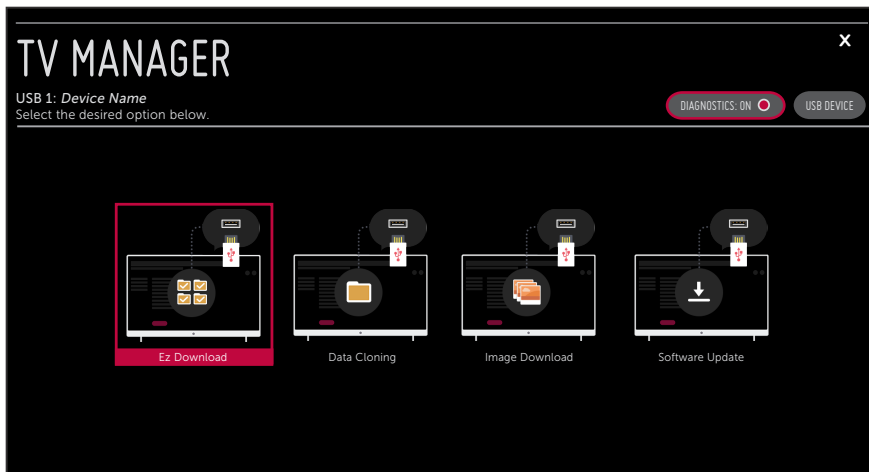

(Continued on next page)

Reference: Updating TV/PTC Software using a USB Memory Device (Cont.)

(Continued from previous page)

Note: Ez Download is always selected by default when you initially access the TV Manager. Also note that Diagnostics is for service use only.

5. Use the arrow keys to select **Software Update**, and then press **OK**.
6. Use the Up/Down arrow keys to select **Update TV Software** or **Update PTC Software**, as applicable, and press **OK**.

Depending on your selection, a list of either TV or PTC software files stored in the LG_DTV folder on the USB memory device will be displayed on the screen. Above the listing of files, you can also see the current version of TV or PTC software. The following example illustrates an Update TV Software screen.

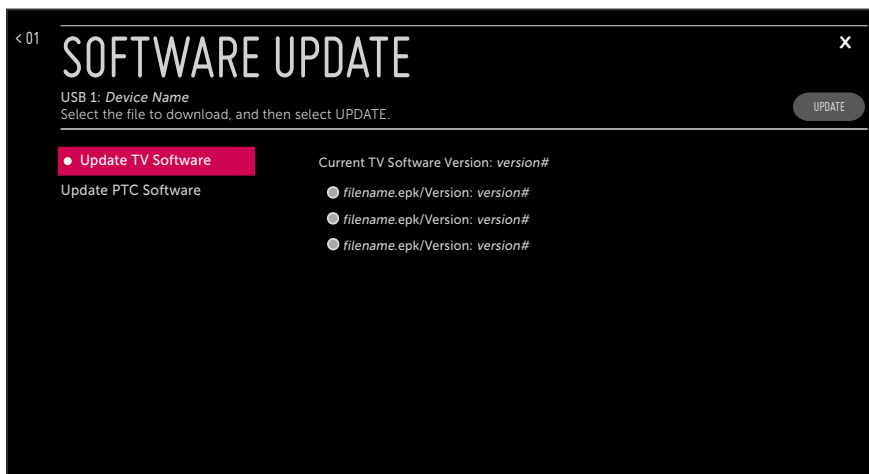

7. Use the arrow keys to select/highlight the update file to download, and then press **OK**.
8. When you are ready to download the update, select **UPDATE** on the screen, and then press **OK** on the Installer Remote.

Software update progress will be displayed on the screen. Do NOT remove the USB device until the software update is complete. When the software update is complete, a "Software Update is completed" pop-up message will briefly be displayed on the screen, and then, the TV will reboot.

Reference: Downloading a Boot Logo Image using a USB Memory Device

This section describes how to download a boot logo image using the TV Manager “Image Download” option, though you may also use the Ez Download utility to download the boot logo, if desired. See “Ez Download Utility” on pages 31 to 34 for further information.

A boot logo image, also known as a “splash screen,” is briefly displayed when the TV is turned ON from its standby (OFF) state.

Boot Logo Image File Guidelines

- File formats supported: Baseline or progressive JPEG or 24-bit (RGB 8x8x8) BMP.
- A JPEG image should be no larger than 6 MB.
- A BMP image should be no larger than 5.93 MB.
- The maximum resolution allowed for the image is 1920 x 1080 pixels.
- Avoid using special characters, such as ?, &, @, etc., in the image filename.

Before You Begin

- The boot logo image file must be stored in a folder named “LG_DTV” in the root directory of the USB memory device.
- Ensure the USB device has been formatted with FAT format.

Download the Boot Logo Image

1. Turn ON the TV, and then insert the USB memory device into the TV's USB port.
2. Press **MENU SETTINGS** on the Installer Remote to display the TV setup menus (TV is in Pass-through Mode) or the Function Menu (TV is not in Pass-through Mode).
3. (TV in Pass-through Mode only) From the Quick Settings Menu displayed at the left of the screen, select the **All Settings**  menu icon and press **OK** to access the advanced TV setup menus.
4. Use the arrow navigation keys to select/highlight either the **General** menu icon from the TV setup menus or the **Safety** menu icon from the Function Menu. Then, press the number “7” key a total of seven times to access the TV Manager.

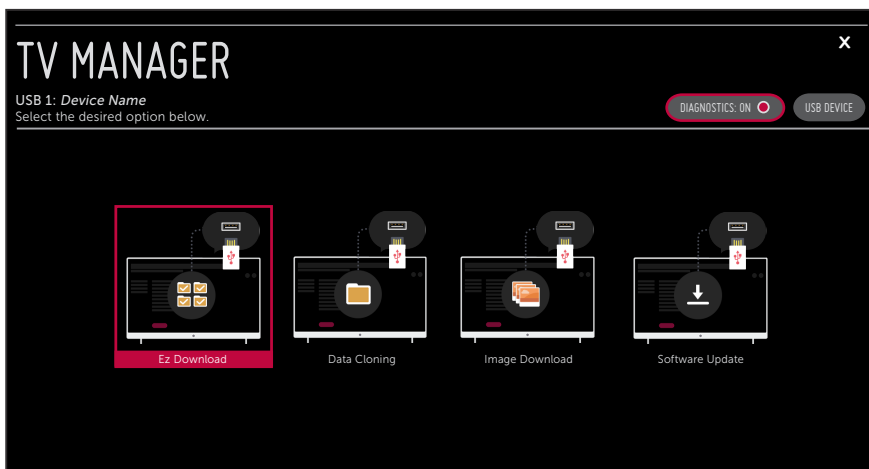

(Continued on next page)

Reference: Downloading a Boot Logo Image using a USB Memory Device (Cont.)

(Continued from previous page)

Note: Ez Download is always selected by default when you initially access the TV Manager. Also note that Diagnostics is for service use only.

5. Use the arrow keys to select **Image Download**, and then press **OK**.

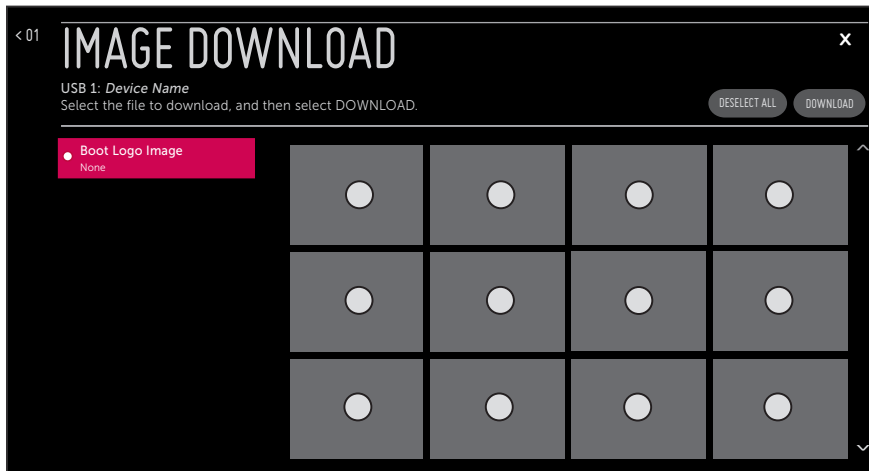

6. In the image area at the right of the screen, use the arrow keys to select/highlight the image file to download. Press **OK** to select a file (a checkmark  identifies a selected file). See also image guidelines at the beginning of this section.
7. When you are ready to download the image file, select **DOWNLOAD** on the screen, and then press **OK** on the Installer Remote.

Download progress will be displayed on the screen. Do NOT remove the USB device until the image download is complete. When the download process is complete, a "Complete" message will be displayed on the screen, and a "DONE" button will be displayed/activated at the top right of the screen.

8. Check the download status—at the left of the screen—for the image to make sure the download was successful, and then press **OK** on the Installer Remote to select **DONE**.

When you select "DONE," the Image Download screen will be redisplayed. You can perform other TV Manager functions, as required, or exit the TV Manager.

Reference: Power Consumption Settings

The following tables assume that Installer Menu item 099 BACK LIGHTING is set as shown below (default value is 255).

Item 099 Back Lighting (Static)	43UT570H		49UT570H		50UT570H		55UT570H		65UT570H	
	Power Consumption (Watts)	Percent Savings	Power Consumption (Watts)	Percent Savings	Power Consumption (Watts)	Percent Savings	Power Consumption (Watts)	Percent Savings	Power Consumption (Watts)	Percent Savings
100	90.6	0%	96.9	0%	98.0	0%	130.8	0%	160.7	0%
90	82.8	9%	89.6	8%	90.2	8%	119.8	8%	145.9	9%
80	77.1	15%	83.3	14%	83.3	15%	110.6	15%	134.0	17%
70	70.3	22%	75.9	22%	75.5	23%	100.1	23%	120.0	25%
60	64.4	29%	69.4	28%	69.6	29%	90.5	31%	107.6	33%
50	58.4	35%	63.0	35%	62.7	36%	81.0	38%	95.3	41%
40	51.9	43%	55.9	42%	54.9	44%	70.8	46%	82.0	49%
30	46.0	49%	49.5	49%	49.0	50%	61.4	53%	69.7	57%
20	39.3	57%	42.2	56%	41.2	58%	50.7	61%	55.9	65%
10	33.3	63%	35.7	63%	34.3	65%	41.4	68%	43.7	73%
1	27.3	70%	29.3	70%	27.4	72%	32.0	76%	33.4	79%

Item 099 Back Lighting (Dynamic)	43UT570H		49UT570H		50UT570H		55UT570H		65UT570H	
	Power Consumption (Watts)	Percent Savings	Power Consumption (Watts)	Percent Savings	Power Consumption (Watts)	Percent Savings	Power Consumption (Watts)	Percent Savings	Power Consumption (Watts)	Percent Savings
200	89.1	0%	97.8	0%	98.1	0%	130.8	0%	160.5	0%
190	82.6	7%	90.2	8%	90.3	8%	119.4	9%	146.1	9%
180	76.5	14%	83.8	14%	83.4	15%	110.2	16%	134.0	17%
170	69.3	22%	76.3	22%	75.5	23%	99.3	24%	119.8	25%
160	64.2	28%	69.7	29%	69.7	29%	89.7	31%	107.3	33%
150	58.1	35%	63.2	35%	62.8	36%	80.3	39%	95.0	41%
140	51.2	43%	56.1	43%	54.9	44%	69.9	47%	81.5	49%
130	45.8	49%	49.6	49%	49.1	50%	60.4	54%	69.2	57%
120	38.8	56%	43.0	56%	41.2	58%	49.7	62%	55.3	66%
110	32.9	63%	35.5	64%	34.3	65%	40.2	69%	43.1	73%
101	27.1	70%	29.0	70%	27.5	72%	30.8	76%	30.8	81%

Note: Values are results of controlled experiments under laboratory conditions.

Reference: Power Consumption Settings (Cont.)

The following tables assume that Installer Menu item 099 BACK LIGHTING is set as shown below (default value is 255).

Item 099 Back Lighting (Static)	49UT577H		55UT577H		65UT577H	
	Power Consumption (Watts)	Percent Savings	Power Consumption (Watts)	Percent Savings	Power Consumption (Watts)	Percent Savings
100	124.7	0%	139.8	0%	170.1	0%
90	116.1	7%	129.4	7%	157.9	7%
80	108.9	13%	120.9	14%	147.4	13%
70	100.4	19%	111.0	21%	135.0	21%
60	92.9	26%	102.3	27%	124.1	27%
50	85.6	31%	93.4	33%	113.5	33%
40	77.5	38%	83.7	40%	101.6	40%
30	70.1	44%	75.0	46%	90.7	47%
20	61.8	50%	65.4	53%	78.4	54%
10	54.1	57%	56.8	59%	67.8	60%
1	46.5	63%	48.4	65%	56.2	67%

Item 099 Back Lighting (Dynamic)	49UT577H		55UT577H		65UT577H	
	Power Consumption (Watts)	Percent Savings	Power Consumption (Watts)	Percent Savings	Power Consumption (Watts)	Percent Savings
200	125.2	0%	139.8	0%	170.0	0%
190	116.7	7%	128.8	8%	157.5	7%
180	109.4	13%	120.5	14%	147.0	14%
170	100.7	20%	110.4	21%	134.7	21%
160	92.4	26%	101.7	27%	123.9	27%
150	85.9	31%	93.4	33%	113.2	33%
140	77.8	38%	83.7	40%	100.0	41%
130	70.3	44%	75.3	46%	90.5	47%
120	61.9	51%	65.5	53%	78.2	54%
110	54.4	57%	56.7	59%	67.2	60%
101	46.8	63%	47.8	66%	56.1	67%

Note: Values are results of controlled experiments under laboratory conditions.

Reference: TV Aux Input Configuration

DIRECT ACCESS Tuning *		TV		ENABLE					MPI DATA				Installer Menu Item 046 START AUX SRCE (Start Aux Source) Value
				Installer Menu			MPI DATA STATUS TYPE 0x41 SOURCES ENABLED (R/W)	DATA STATUS TYPE 0xD2 CURRENT AV SOURCE (R)	DATA STATUS TYPE 0x0D AUX SOURCE (R)				
Installer Menu Item 029 REMAP AUX INPS = 0	Installer Menu Item 029 REMAP AUX INPS = 1	Aux Input	Input Mode	Item	Function	Value	Enable Bit	Label	Value	Value	Description		
131-0	91-0	AV (Rear)	CV	39	REAR AUX EN	1	1	Rear Video (Aux)	1	0	VIDEO	1	
132-0	92-0	HDMI 2	DTV	91	HDMI2 ENABLE	1	2	S-Video Rear	2	0	VIDEO	5	
			PC			2				2	COMPUTER		
133-0	93-0	HDMI 1	DTV	35	HDMI1 ENABLE	1	3	Front Computer	3	0	VIDEO	3	
			PC			2				2	COMPUTER		
135-0	95-0	HDMI 3	DTV	92	HDMI3 ENABLE	1	5	NTSC Rear Computer	5	0	VIDEO	7	
			PC			2				2	COMPUTER		

* Use Installer Remote to enter channel number indicated based on REMAP AUX INPS Installer Menu setting.

Reference: *b*-LAN Setup & Overview

The *b*-LAN module is internal to the TV. It allows hotel/institution head end equipment with *b*-LAN technology to communicate, via the institution's RF distribution system, with the TV for configuration and control.

Installer Menu item 118 POWER SAVINGS controls the power circuitry for both the embedded *b*-LAN module and the GAME CONTROL/MPI port. The default value is 3—the *b*-LAN module is only powered when the TV is turned ON. See chart below.

POWER SAVINGS	TV OFF	TV ON
	<i>b</i> -LAN & GAME CONTROL/MPI Port Power	<i>b</i> -LAN & GAME CONTROL/MPI Port Power
1	On	On
3 (default)	Off	On

A *b*-LAN enabled head end device, such as an LG FMA-LG102, broadcasts over the RF distribution system to communicate to multiple TVs. When the TV is first installed, it must be turned ON in order for its embedded *b*-LAN module to receive communication from the head end device. At this point, if it is desired for the *b*-LAN module to always be powered, including while the TV is turned OFF, set Installer Menu item 118 POWER SAVINGS to 1.

Also, if MPI communication is required for external MPI control, set Installer Menu item 118 POWER SAVINGS to 1 so that the GAME CONTROL/MPI port circuitry is always powered.

 **Caution: POWER SAVINGS should NEVER be set to 7. This setting is intended for factory use only.**

Reference: FTG Mode via EBL (Local Configuration)

Note: FTG Device Configuration Application version 5.5.8 is the latest and final release of this software. There will be no future releases. However, the application may still be used for FTG Mode via EBL configuration, as described below.

Note: If you are using an FMA head end device for remote management and you wish to include FTG Installer Menu settings for this model in an FMA Configuration (.fma) file, you will need to “Read” FTG Installer Menu settings from a Master UT570H or UT577H TV that is already configured for FTG Mode via EBL. That is, you will need to perform all steps of the procedure below before you can add an FTG Installer Menu profile for this model to the FMA Configuration List in the FMA Configuration Utility. See the *Free-To-Guest (FTG) Device Configuration Application User Guide* for further information on the FMA Configuration Utility.

The following steps outline local FTG configuration of individual TV EBLs using a direct PC-to-TV (EBL) connection. Refer to the *Free-To-Guest (FTG) Device Configuration Application User Guide* for further information. FTG Device Configuration Application software is available online at: www.lg.com/us/business/display-solutions/ftg.

Note: If the TV CPU is already in FTG Mode, you cannot use this procedure to make changes to the FTG Channel Map and FTG Installer Menu settings. Refer to FTG Mode information on pages 7 to 9 for further details. If the preceding condition applies, but you wish to switch the TV to FTG Mode via EBL, see Reference section, “Restoring Factory Defaults on the TV(s),” for further information before proceeding.

1. Install (if necessary) and launch the FTG Device Configuration Application on the PC that will be used to configure the EBL.
2. Build an FTG Channel Map using the FTG Channel Map Editor in the FTG Channel Map Configuration Utility (or, if applicable, open an existing FTG Configuration [.rml] file).

Note: Up to 141 logical channels can be defined in the FTG Channel Map.

3. Connect the PC to the TV-LINK CFG jack on the TV’s rear jack panel using a USB-to-TTL serial cable (TTL-232R-5V-AJ). If necessary, install the device driver on the PC.

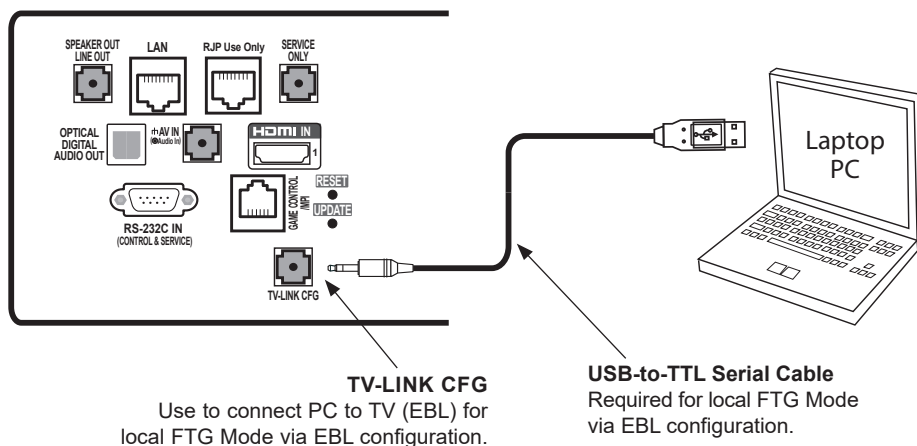

4. Turn ON the TV.

(Continued on next page)

Reference: FTG Mode via EBL (Local Configuration) (Cont.)

(Continued from previous page)

Note: If Installer Menu item 118 POWER SAVINGS is set to 3 (default), the TV must be ON in order for steps 5 and 6 to be successful.

5. (Optional) Since the application is no longer being updated with new model profiles, these model are unknown to the application, which means that it is not possible to use the FTG Installer Menu Configuration Utility to change Installer Menu items.

Therefore, if you would like to make any changes to the Installer Menu items, access the Installer Menu on the TV and make the desired/applicable changes to the items BEFORE configuring the EBL for FTG Mode in the next step.

6. "Write" the FTG Channel Map to the EBL (switches the EBL from Pass-through Mode to FTG Mode).

Note: After a "Write" of new data, the TV will briefly display a green text banner that shows the EBL firmware version and release date.

7. "Read" the current FTG Installer Menu settings from the EBL using the FTG Installer Menu Configuration Utility.

Note: When you "Read" the settings from the EBL, a pop-up notice will be displayed (see example below) to indicate that the chassis ID of this model is unknown and so a generic Installer Menu profile will be loaded. Click **OK** to dismiss the pop-up window and continue. The resulting "generic" profile contains all Installer Menu items, including a number of items that may not be applicable for this model. Refer to the Installer Menu section of this document for detailed information on Installer Menu items that are specific to the UT570H/UT577H.

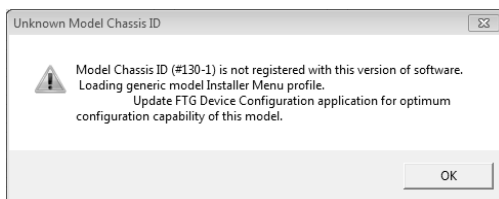

8. Save the FTG Channel Map and FTG Installer Menu settings to an FTG Configuration (.rml) file for future use.
9. Tune the TV to a logical channel in the FTG Channel Map.

Note: For information on remote management using an FMA, refer to the appropriate Installation & Configuration document for the FMA in use. For example, for an FMA-LG102, refer to the **FMA-LG102 Installation & Configuration Guide**.

Reference: Auto Input(s) Sensing Feature

This section provides detailed settings information for Installer Menu item 042 AUTO INPUTS. To disable auto-sensing for all available Aux inputs, set item 042 to 0. To enable auto-sensing for all available Aux inputs, set item 042 to 255. For specifications on all other available settings (i.e., settings for individual inputs), refer to the Aux Inputs Values table on the following page.

Note: When both item 042 AUTO INPUTS *and* item 041 SIMPLINK EN are enabled in the Installer Menu, HDMI inputs will be detected by SIMPLINK, but the Auto Input(s) Sensing Feature will not function.

In the Installer Menu, an informational text code is displayed at the right of each Auto Inputs value, for example:

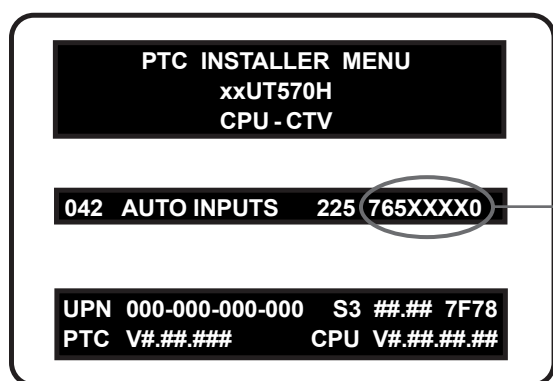

AUTO INPUTS Text Code

This example illustrates Installer Menu item 042 value 225, which enables auto-sensing for all available Aux inputs. The input #s in the text code (7, 6, 5, 0 in this example) identify the enabled Aux inputs. See the Input # Assignments table below for a listing of the UT570H/UT577H Aux inputs and their corresponding text code input #s. The Auto Inputs Values table on the following page shows the text codes for all item 042 values.

Each Auto Inputs text code consists of eight characters that identify the Aux input(s) for which auto-sensing is enabled. The following table identifies the Installer Menu text code input # for each Aux input that is available on the UT570H/UT577H TV models. The table also identifies the Installer Menu item associated with each Aux input. Remember that in order for auto-sensing to be enabled for an input, that input must also be enabled in the Installer Menu.

Input # Assignments

Installer Menu Text Code Input #	Aux Input	Installer Menu	
		Item	Function
0	AV	039	REAR AUX EN
6	HDMI 1	035	HDMI1 ENABLE
7	HDMI 2	091	HDMI2 ENABLE
5	HDMI 3	092	HDMI3 ENABLE

Reference: Auto Input(s) Sensing Feature (Cont.)

The following table shows all available Aux inputs as if each is enabled in the Installer Menu. The Installer Menu text codes for item 042 will be altered accordingly if any of the available Aux inputs are disabled in the Installer Menu.

Auto Inputs Values

Item 042 Value	Aux Inputs				Installer Menu Text Code
	AV	HDMI 1	HDMI 2	HDMI 3	
000	Disabled	Disabled	Disabled	Disabled	DDDXXXXD
001	Enabled	Disabled	Disabled	Disabled	DDDXXXX0
032	Disabled	Disabled	Disabled	Enabled	DD5XXXXD
033	Enabled	Disabled	Disabled	Enabled	DD5XXXX0
064	Disabled	Enabled	Disabled	Disabled	D6DXXXXD
065	Enabled	Enabled	Disabled	Disabled	D6DXXXX0
096	Disabled	Enabled	Disabled	Enabled	D65XXXXD
097	Enabled	Enabled	Disabled	Enabled	D65XXXX0
128	Disabled	Disabled	Enabled	Disabled	7DDXXXXD
129	Enabled	Disabled	Enabled	Disabled	7DDXXXX0
160	Disabled	Disabled	Enabled	Enabled	7D5XXXXD
161	Enabled	Disabled	Enabled	Enabled	7D5XXXX0
192	Disabled	Enabled	Enabled	Disabled	76DXXXXD
193	Enabled	Enabled	Enabled	Disabled	76DXXXX0
224	Disabled	Enabled	Enabled	Enabled	765XXXXD
225	Enabled	Enabled	Enabled	Enabled	765XXXX0
255	Enabled	Enabled	Enabled	Enabled	765XXXX0

X = Aux input is Disabled or Not Available (i.e., on these TV models)

D = Auto-sensing for input is Disabled

Input # = Auto-sensing for input is Enabled

Reference: RJP Model List & Input Auto-sensing Hierarchy

RJP Legacy Models

- RJP-101M
- RJP-101ML
- RJP-110F
- RJP-110FW
- RJP-110W
- RJP-110WBR
- RJP-110S
- RJP-120G
- RJP-120T
- RJP-201B/202B

RJP Scaler Models

- RJP-301B

RJP Input Auto-sensing Hierarchy

Priority	Video	Audio
1st (Highest)	Digital Video In	Audio In (3.5mm)
2nd	PC Video In	Audio In (L/R)
3rd	Video In	Digital Video In

Reference: Restoring Factory Defaults on the TV(s)

This section describes how to restore all factory defaults or just the Installer Menu factory defaults either on a single TV that is currently in Pass-through Mode, FTG Mode, Application Tuning Mode, etc. or on multiple TVs that are currently in FTG Mode.

Restore All Factory Defaults

This section describes how to restore a single TV, regardless of its mode, to a factory default condition. The following procedure requires that you contact LG technical support to obtain a predefined value/password for Installer Menu item 117 FACT DEFAULT that enables access to initiate a factory “IN-STOP” process, which restores all factory defaults. This procedure will also reactivate the First Use Wizard.

1. Use the Installer Remote to access the TV’s Installer Menu, navigate to Installer Menu item 117 FACT DEFAULT, and key in the value provided by technical support. Then, press **OK**.
2. At the prompt for confirmation, key in the password provided by technical support. This will initiate the IN-STOP that restores the factory defaults on the TV.

Installer Menu Item 117 FACT DEFAULT

If the TV is currently in Pass-through Mode, you can set Installer Menu item 117 FACT DEFAULT to 1 to restore the Installer Menu factory defaults and clear the PTC Channel Map, including any assigned channel icons and custom text labels. Note, however, that if a complete restoration of the TV’s factory defaults is required, see “Restore All Factory Defaults” above.

Additional FTG Mode via CPU Options

There are two additional options for restoring Pass-through Mode/Installer Menu factory defaults on TVs that are in FTG Mode via the CPU. The first enables you to restore a single TV to Pass-through Mode, while the second enables you to restore multiple TVs to Pass-through Mode at one time. However, both options require that you create a “Restore_Pass-through_Mode.tlx” file, i.e., an FTG Configuration file with no data. Refer to the **Cloud Configuration Tool User Guide** for further information.

- Using a USB memory device, import a “Restore_Pass-through_Mode.tlx” file to the TV. Refer to “Importing a Clone File” on pages 51 to 54 for further information on the import procedure.
- If your system uses a Pro:Centric server for remote management of UT570H/UT577H TVs that are in FTG Mode, use the Pro:Centric Admin Client to load a “Restore_Pass-through_Mode.tlx” file on the Pro:Centric server. Refer to the **Pro:Centric Server Admin Client User Guide** for further information.

Additional FTG Mode via EBL Options

There are two additional options for restoring Pass-through Mode/factory defaults on TVs that are in FTG Mode via the EBL. The first enables you to restore a single TV to Pass-through Mode, while the second enables you to restore multiple TVs to Pass-through Mode at one time.

 **Note: While the IN-STOP process described above will clear both the PTC and the CPU, both options below only clear the PTC. Thus, the current Channel Map and TV setup menu settings will remain in the CPU after the reset is completed.**

- Using a direct PC-to-TV connection, “Write” an unpopulated Channel Map—that is, a Channel Map with 0 (zero) channels—to the TV. See Reference section, “FTG Mode via EBL (Local Configuration),” and/or the **Free-To-Guest (FTG) Device Configuration Application User Guide** for further information.
- If your system uses an FMA for remote management/broadcast configuration, configure the FMA device with an FMA Configuration (.fma) file that only contains a “0 Mapped Channels” FTG Channel Map to broadcast to the TV EBL(s). Refer to the **Free-To-Guest (FTG) Device Configuration Application User Guide** and/or the Installation & Configuration Guide for the FMA device for further information.

Reference: Using the TV Zoning Feature

This section describes the TV Zoning feature available with the UT570H/UT577H model TVs. The TV Zoning feature enables you to create localized configurations for TVs in selected “Zones” within the installation site, for example, a hotel lobby, fitness center, restaurant, etc. This feature is primarily intended for use when the TV is configured for FTG Mode via CPU operation; however, selected elements of TV Zoning (Installer Menu and Setup Menu profile Zone assignments), may also be used with TV cloning processes using a Clone (.tlx) file.

Refer to the appropriate section(s) below for further information on the TV Zoning feature and how to set the TV Zone # in a TV that is currently in Pass-through Mode.

Using the TV Zoning Feature with FTG Mode via CPU Configuration

The Cloud Configuration Tool may be used to create an FTG Configuration (.tlx) file that contains multiple Installer Menu and Setup Menu profiles, each with its own Zone assignment. Up to nine unique Zones can be designated for UT570H/UT577H FTG Installer Menu and/or Setup Menu profiles. Zone restrictions can also be placed on individual channels in the FTG Channel Map. Thus, for example, you may create an FTG Installer Menu and/or Setup Menu profile to uniquely configure a TV in the hotel lobby and also restrict the channels that are available to be tuned on that TV.

The TV Zone # must be set appropriately on each TV in order for the TVs to be configured correctly. See “Set the TV Zone # in the TV” on page 82, and set the TV Zone # in all the TVs in a select area, so that the TVs are configured with corresponding FTG Installer Menu and/or Setup Menu settings and/or can omit channels that have been restricted in the FTG Channel Map. TV Zone 0 is the default TV Zone #.

The following subsections briefly describe how to assign Zones in the Cloud Configuration Tool. Refer to the **Cloud Configuration Tool User Guide** for further information.

FTG Installer Menu Profile Zone Assignments

The Cloud Configuration Tool / Installer Menu web page enables you to create multiple Installer Menu profiles for the same chassis model, each with a different Zone assignment (default = Zone 0), to be included in an FTG Configuration (.tlx) file. For example, you may wish to create one Installer Menu profile for the UT570H TV in the hotel lobby and another Installer Menu profile for the UT570H TV in the fitness center, both of which are different from the Installer Menu profile used for UT570H TVs in standard guest rooms. The TV Zoning feature enables you to save multiple UT570H FTG Installer Menu profiles, each with its own Zone assignment, in one FTG Configuration file. If each TV in the aforementioned locations (Zones) has had its TV Zone # set appropriately, as described in the procedure on page 82 or via the EZ-Manager Wizard, the TV(s) will only be configured by the Installer Menu profile that matches its(their) Zone setting.

In the Cloud Configuration Tool / File Manager web page, you can also change the Zone assignment for each Setup Menu profile already present in the FTG Configuration List. See the File Manager and Installer Menu web page overviews on pages 58 and 60 for further information. Note that Setup Menu profiles cannot be created in the Cloud Configuration Tool; they must be saved (exported) from a TV.

FTG Channel Map Zone Restrictions

In the Cloud Configuration Tool / Channel Map web page, you can place Zone restrictions on individual channels that may be prohibited or deemed unsuitable for certain locations. One or more Zone restrictions (1–8) may be placed on each channel that is to be restricted. For example, if you wish to restrict a channel from Zones 2 and 4, select both “Zone 2” and “Zone 4” in the Restricted from Zones field when defining or editing that channel.

Note: While a channel can be restricted from up to eight Zones, a TV can only ever be in (set for) one Zone. See also the Channel Map web page overview on page 59.

Reference: Using the TV Zoning Feature (Cont.)

At the same time, keep in mind that the TV Zone designations are not mutually exclusive. That is, you may opt to place Zone restrictions on selected channels in the FTG Channel Map, but at the same time, you can choose to configure all TVs at the site with the same Installer Menu and/or Setup Menu settings. For example, an FTG Configuration (.tlx) file being used to configure the TVs at a site may contain multiple Installer Menu and Setup Menu profiles with different Zone assignments, as well as an FTG Channel Map with Zone restrictions on several channels. Each TV that still has the default TV Zone 0 setting will *only* be configured by the Installer Menu and/or Setup Menu profile(s) with a Zone 0 designation. If, on the other hand, the TV Zone # is set to 1, the TV will first look in the file for the UT570H/UT577H Installer Menu and/or Setup Menu profile(s) with a Zone 1 designation. If none of the UT570H/UT577H Installer Menu and/or Setup Menu profiles has a Zone 1 designation, the TV will then look for the UT570H/UT577H profile(s) with a Zone 0 designation. For the FTG Channel Map configuration, when the TV Zone # is set to 0, the TV will ignore any Zone restrictions (1–8) that may be placed on channels in the FTG Channel Map. However, when the TV Zone # is set to 1, the TV will omit any channels that have been restricted from Zone 1 in the FTG Channel Map.

Using the TV Zoning Feature with Cloning Configuration

A location-specific configuration / Clone (.tlx) file may be saved (exported) from a Master TV and then be used to configure Target TVs. For example, if the TV Zone # in the Master TV is set to 3 before the Clone file export is initiated, the Master TV's Installer Menu and Setup Menu profiles will be saved with the TV Zone 3 assignment. In order to configure the Target TVs with the Zone 3 Installer Menu and Setup Menu profiles exported from the Master TV, you must set the TV Zone # accordingly in the Target TVs before importing the Clone file. See “Set the TV Zone # in the TV” on the following page. Also, see “Cloning Procedures” on pages 49 to 54 for additional information on the cloning processes. TV Zone 0 is the default TV Zone #.

Set the TV Zone # in the TV

You can set the TV Zone # in the Solution Settings / EZ-Manager Wizard (see “Solution Settings / EZ-Manager Wizard” on pages 21 to 30) or, if the TV is in Pass-through Mode, via the TV's setup menus as described below. Note that the following procedure can only be performed while the TV is in Pass-through Mode. You will also be able to specify a Label (North, South, East, West) and Room Number for this TV, if desired.

1. Turn ON the TV.
2. Press **MENU SETTINGS** on the Installer Remote, and use the arrow navigation keys to select/highlight the **General** menu option. Then, press **OK**.
3. In the General Menu, use the Up/Down arrow keys to select **Room Info**, and then press **OK**.
4. In the Room Info screen, complete the appropriate fields as described below. Use the Up/Down arrow keys on the Installer Remote to navigate between each of the fields.
 - TV Zone: Enables you to set a TV Zone # so that the TV can be configured with Installer Menu and/or Setup Menu settings intended only for the assigned Zone. The Installer Menu and/or Setup Menu settings may be provided in a Clone/Configuration (.tlx) file. If the TV is being configured for FTG Mode, the TV Zone # setting also allows the TV to omit channels that have been restricted in the FTG Channel Map (see “FTG Channel Map Zone Restrictions” on page 81).

To change the TV Zone, select/highlight the **TV Zone** field and press **OK**. Then, use the Left/Right arrow keys to specify the desired TV Zone # (0–8). Press **OK** when you are finished.

(Continued on next page)

Reference: Using the TV Zoning Feature (Cont.)

(Continued from previous page)

- **Label:** Allows you to select a North, South, East, or West text label for this TV. Select/highlight the **Label** field and press **OK**. Then, use the Up/Down arrow keys to select the applicable label. Press **OK** when you are finished.
- **Room Number:** Allows you to specify the number of the room—up to 16 characters—in which the TV is located. To enter a room number, use the Up/Down arrow keys to select/highlight the **Room Number** field and press **OK**. You can then use the number keys on the Installer Remote to direct enter a room number, or you can use the arrow keys to select the appropriate alphanumeric character(s) from the pop-up virtual keyboard at the bottom of the screen. When you are done, select **Enter** from the virtual keyboard, and then press **OK** on the Installer Remote.

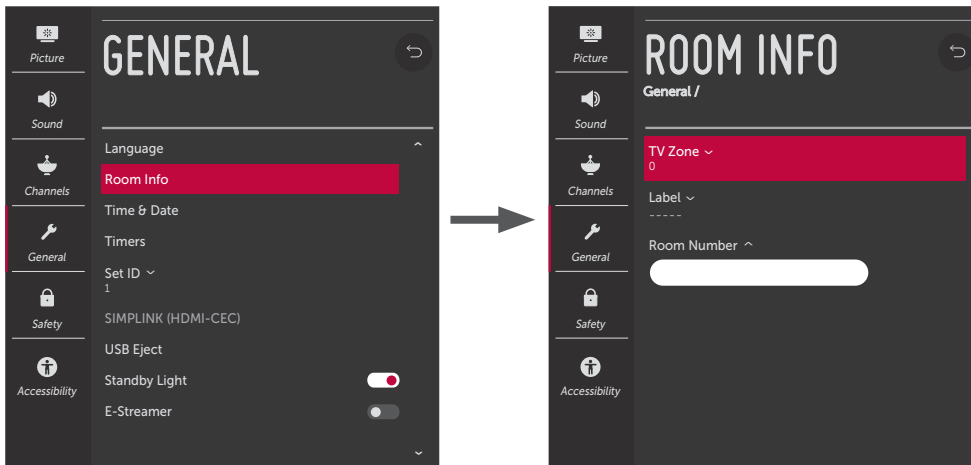

5. When you have completed the fields as necessary, press **↵** to return to and/or exit the TV menus, or press **MENU SETTINGS** to return to program viewing.

Reference: UT570H/UT577H Rear and Side Jack Panels

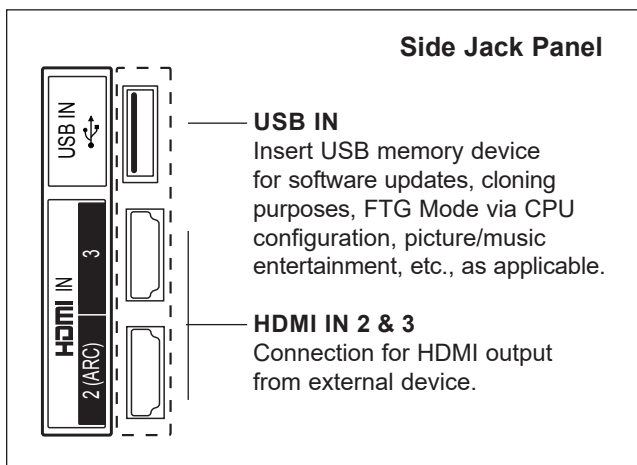
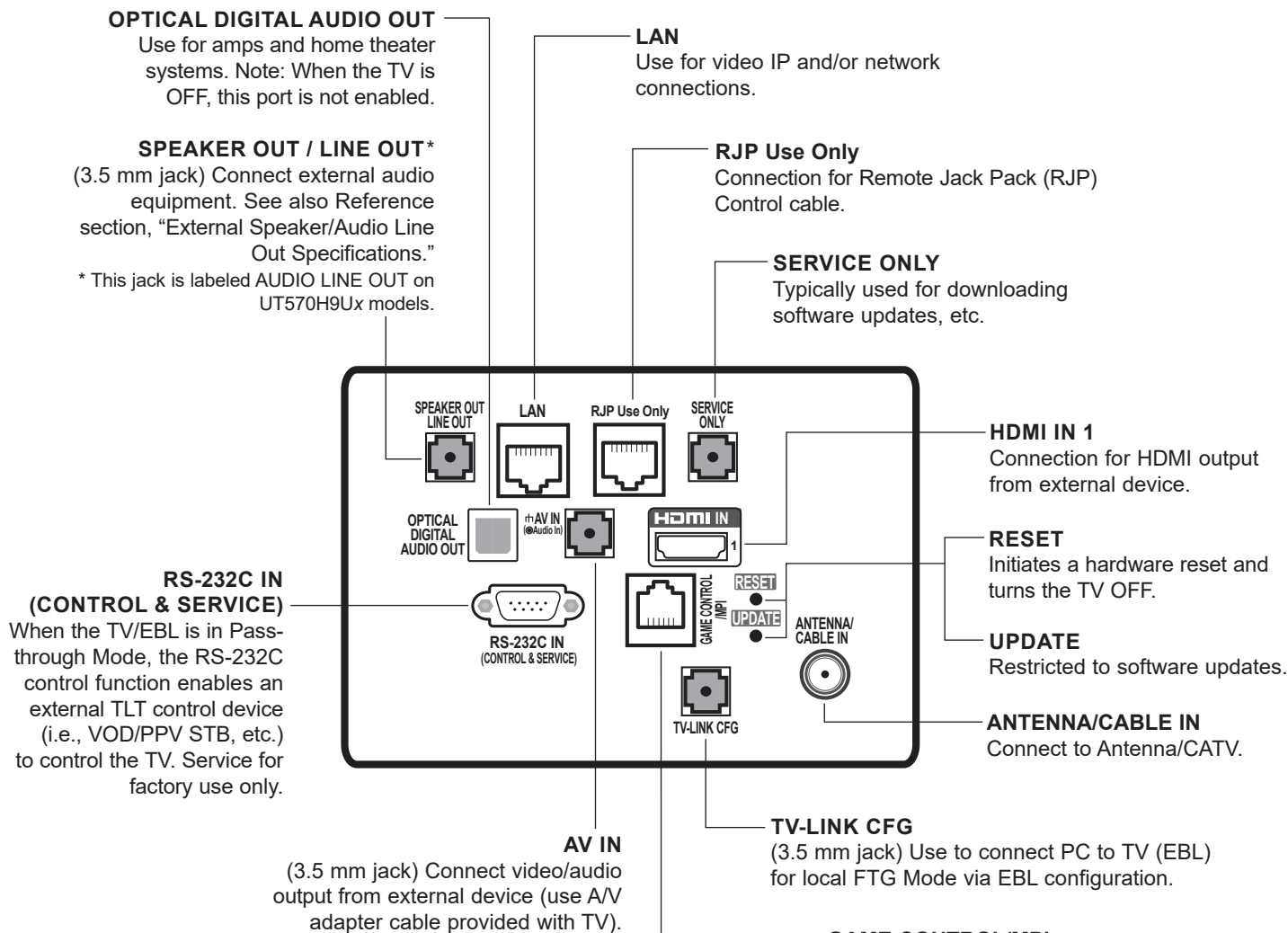

Note: Placement of connector/port labels varies slightly depending on model.

Caution: Do NOT connect a standard Ethernet cable to the RJP port, as this may damage the TV and network equipment.

Reference: External Speaker/Audio Line Out Specifications

The SPEAKER OUT / LINE OUT 3.5 mm stereo jack on the rear panel of UT570H0Ux/UT577H0Ux models provides stereo speaker signal outputs (fixed speaker, variable speaker, or fixed line level [amplifier]) for external audio equipment, while the AUDIO LINE OUT 3.5 mm stereo jack on the rear panel of UT570H9Ux models provides stereo analog audio output for external audio equipment. Set Installer Menu item 097 AUDIO OUTPUT as required in accordance with both the applicable TV model, as well as the external audio equipment connected to the TV. Also, refer to the following diagram for pinout details.

 **Caution: Do NOT insert a mono plug, as this may damage the TV.**

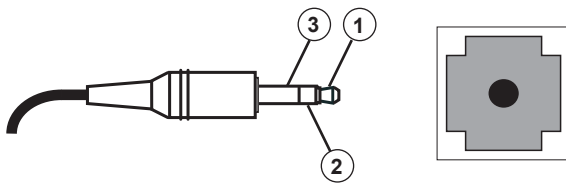

-
- | | |
|---|-----------------|
| 1 | LEFT (Tip) |
| 2 | RIGHT (Ring) |
| 3 | GROUND (Sleeve) |
-

Reference: Installer Remote Control Typical Key Functions

The LG Installer Remote is supplied with and dedicated to operate the TV. The LG Installer Remote illustrated below shows typical remote control functions and is provided for reference only. This Installer Remote may vary from the Installer Remote supplied with the TV.

⏻ (POWER)
Turns the TV ON or OFF.

TV/DVD
Select the remote's operating mode: TV or DVD.

INPUT
Displays available Aux inputs.
(Q. MENU/MARK options N/A for these TV models)

NUMBERS (0 - 9) & DASH
Use to enter a channel or program number. Dash is used for sub-channel numbers such as 2-1, 2-2, etc.

FLASHBK (FLASHBACK)
Returns to the previously tuned channel or input.

VOLUME UP/DOWN
Increases/decreases sound level.

CC
Activates subtitles.

TIMER
Sets the amount of time before the TV automatically turns itself OFF.

MUTE
Switches sound ON or OFF.

CHANNEL/PAGE UP/DOWN
Changes channels based on channels in the channel lineup. Moves to previous or next screen in Pro:Centric channel guide.

DVD/USB buttons
Use to control DVD player or view USB memory device content.

SIMPLINK
Accesses the AV devices connected to the HDMI ports of the TV.
(PIP/SWAP options N/A for these TV models)

SAP
Analog Mode: Selects MTS sound (Mono, Stereo, or SAP). DTV Mode: Changes audio program language, if additional languages are available.*

Q.MENU

TV DVD INPUT MARK

1 2 3
1: @, 2: abc, 3: def

4 5 6
4: ghi, 5: jkl, 6: mno

7 8 9
7: pqrs, 8: tuv, 9: wxyz

0
0: L

FLASHBK

CHAR/NUM
CC, TIMER, DELETE, MUTE

VOL
+, -

CH
↑, ↓

PORTAL INFO GUIDE

OK ENTER
◀, ▶, ▲, ▼

RETURN
↶

MENU SETTINGS EXIT
MENU SETTINGS, EXIT

Color buttons
Color buttons access special functions in some menus.

Arrows (Up/Down/Left/Right) & OK/ENTER
Use to navigate on-screen menus, direct tune channels, and adjust TV settings.

MENU SETTINGS
Displays and removes the TV setup menus (or, if applicable, the Function Menu).

PORTAL
Displays and removes the Pro:Centric interactive menu.

INFO
Displays channel information.

GUIDE
Displays and removes the Pro:Centric channel guide/EPG.

↶ (RETURN)
Returns one level to the previous menu/display.

EXIT
Clears all on-screen displays and returns to program viewing.

* SAP notes:

- If SAP is selected and no SAP is provided, sound may not be heard on channel.
- Each channel may have its own SAP setting.
- Each time digital channels are tuned, the TV attempts to locate the default audio program language. If the default audio program language is not available, the TV will use the first available audio program.

Reference: TLT Communication Parameters

RS-232C Configuration

**RS-232C IN (CONTROL)
DB9 Serial Port on TV**

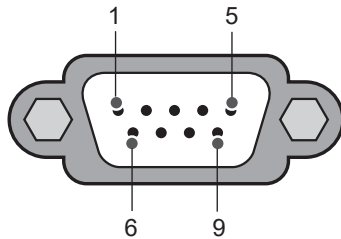

RS-232C IN (CONTROL) Port Pin Configuration

Pin Number	Description
1	3.5 V
2	RXD
3	TXD
4	IR Data Pass-through *
5	GND
6	No Connection
7	No Connection
8	No Connection
9	No Connection

* Normally low signal with logic high pulses.

If your configuring device has a DB9-Male serial port, use a DB9-Female to DB9-Female null-modem (crossover) cable to connect the device to the TV.

Communication Parameters

- Baud rate: 9600 bps (UART)
- Parity: None
- Data length: 8 bits
- Stop bit: 1 bit

Command Reference List

Note: Commands may work differently depending on model and signal.

		Command 1	Command 2	Data (Hexadecimal)		Command 1	Command 2	Data (Hexadecimal)	
01.	Power	k	a	00 / 01	11.	OSD Select	k	l	00 / 01
02.	Aspect Ratio	k	c	(see page 89)	12.	Remote Control Lock Mode	k	m	00 / 01
03.	Screen Mute	k	d	00, 01, 10	13.	Balance **	k	t	00–64
04.	Volume Mute	k	e	00 / 01	14.	Color Temperature *	x	u	00–64
05.	Volume Control	k	f	00–64	15.	Equalizer	j	v	(see page 91)
06.	Contrast *	k	g	00–64	16.	Tune Command	m	a	(see page 91)
07.	Brightness *	k	h	00–64	17.	Channel Add/Delete	m	b	00 / 01
08.	Color *	k	i	00–64	18.	Key	m	c	(see page 92)
09.	Tint *	k	j	00–64	19.	Control Backlight	m	g	00–64
10.	Sharpness *	k	k	00–32	20.	Input Select (Main)	x	b	(see page 92)

* These features are also adjustable in the Picture Menu.

** This feature is also adjustable in the Sound Menu.

Reference: TLT Communication Parameters (Cont.)

Transmitting / Receiving Protocol

This communication protocol transmits and receives 1-byte ASCII data representation for each Command, Set ID, and Data character. Therefore, a standard ASCII terminal program can be used to send and receive the protocol.

Command Structure

[Command1][Command2][][Set ID][][Data][CR]

The following table describes the parameters.

[Command 1]	First part of command to control the TV: j, k, m, or x. Corresponding transmission data of 0x6A, 0x6B, 0x6D, or 0x78, respectively.
[Command 2]	Second part of command to control the TV.
[Set ID]	Choose the [Set ID] value to match the Set ID number in the General Menu. The Set ID valid range is decimal 1 to 99. If the [Set ID] value is sent as [00], every connected display will act on the command. Note: The [Set ID] value should be entered in an ASCII terminal program as hexadecimal 00 to 63 values; however, note that each character of the hexadecimal value is transmitted as the ASCII value of that character. For example: [00] since ASCII 0=0x30, would be sent as "3030" [0A] since ASCII A=0x41, would be sent as "3041" [63] since ASCII 6=0x36 & ASCII 3=0x33, would be sent as "3633"
[Data]	Enter the command's required data (hexadecimal—see [Set ID] note above for correct translation). Enter Data [FF] to read status of the function.
[CR]	Carriage Return (ASCII value 0x0D)
[]	Space (ASCII value 0x20)

OK Acknowledgment

[Command2][][Set ID][][OK][Data][x]

The display responds with OK acknowledgment in the format shown above after receiving valid Command and Data values. The [Data] value in the response is either the current status (if Data [FF] was sent) or the [Data] value that was sent in the acknowledged control command.

Error Acknowledgment

[Command2][][Set ID][][NG][Data][x]

The display responds with NG (error) acknowledgment in the format shown above after receiving abnormal data from non-viable functions or communication errors. The [Data] value in the response is the [Data] value that was sent in the acknowledged control command.

Reference: TLT Communication Parameters (Cont.)

Data Conversion (Hexadecimal : Decimal)

In cases where decimal values are shown in commands, refer to following conversion examples to enter the [Data] value in the terminal program as hexadecimal.

Note: The Channel Tune (ma) Command uses two-byte hexadecimal values ([Data]) to represent the channel number.

00: Step 0	32: Step 50 or Set ID 50	FE: Step 254
01: Step 1 or Set ID 1	33: Step 51 or Set ID 51	FF: Step 255
...
0A: Step 10 or Set ID 10	63: Step 99 or Set ID 99	01 00: Channel 256
...
0F: Step 15 or Set ID 15	C7: Step 199	27 0E: Channel 9998
10: Step 16 or Set ID 16	C8: Step 200	27 0F: Channel 9999
...

TLT Command Detailed Descriptions

Note: Commands may work differently depending on model and signal.

01. Power (Command: k a)

- To control TV power (ON/OFF).

Command (Control) Structure

[k][a][][Set ID][][Data][CR]

Data 00: Power Off 01: Power On

Acknowledgment

[a][][Set ID][][OK/NG][Data][x]

- To show TV power status (ON/OFF).

Command (Status) Structure*

[k][a][][Set ID][][FF][Cr]

Acknowledgment

[a][][Set ID][][OK][Data][x]

* Similarly, when Data [FF] is sent for other functions (based on this format), the Acknowledgment feedback returns status about each function.

02. Aspect Ratio (Command: k c)

To adjust the aspect ratio.

Command Structure

[k][c][][Set ID][][Data][CR]

Data 01: Normal Screen (4:3)
02: Wide Screen(16:9)
04: Zoom
06: Set by Program/Original
09: Just Scan
10 to 1F: Cinema Zoom 1 to 16
0C: Cinemascope (21:9)

Acknowledgment

[c][][Set ID][][OK/NG][Data][x]

- Using the PC input, you can select either 16:9 or 4:3 screen aspect ratio.
- In DTV/HDMI/Component mode (high-definition), Just Scan is available.
- Full wide mode may work differently based on model and is supported for DTV fully and ATV / AV partially.

03. Screen Mute (Command: k d)

To control screen mute.

Command Structure

[k][d][][Set ID][][Data][CR]

Data 00: Screen Mute Off (Picture On)
Video Mute Off
01: Screen Mute On (Picture Off)
10: Video Mute On*

Acknowledgment

[d][][Set ID][][OK/NG][Data][x]

* In case of Video Mute On only, the TV will show OSD. In case of Screen Mute On, the TV will not show OSD.

04. Volume Mute (Command: k e)

To control volume mute.

Command Structure

[k][e][][Set ID][][Data][CR]

Data 00: Volume Mute On (Volume Off)
01: Volume Mute Off (Volume On)

Reference: TLT Communication Parameters (Cont.)

- Acknowledgment
[e][][Set ID][][OK/NG][Data][x]
05. Volume Control (Command: k f)
To adjust volume.
Command Structure
[k][f][][Set ID][][Data][CR]
Data Min: 00 to Max: 64
Acknowledgment
[f][][Set ID][][OK/NG][Data][x]
06. Contrast (Command: k g)
To adjust screen contrast.
Command Structure
[k][g][][Set ID][][Data][CR]
Data Min: 00 to Max: 64
Acknowledgment
[g][][Set ID][][OK/NG][Data][x]
07. Brightness (Command: k h)
To adjust screen brightness.
Command Structure
[k][h][][Set ID][][Data][CR]
Data Min: 00 to Max: 64
Acknowledgment
[h][][Set ID][][OK/NG][Data][x]
08. Color (Command: k i)
To adjust the screen color.
Command Structure
[k][i][][Set ID][][Data][CR]
Data Min: 00 to Max: 64
Acknowledgment
[i][][Set ID][][OK/NG][Data][x]
09. Tint (Command: k j)
To adjust the screen tint.
Command Structure
[k][j][][Set ID][][Data][CR]
Data Red: 00 to Green: 64
- Acknowledgment
[j][][Set ID][][OK/NG][Data][x]
10. Sharpness (Command: k k)
To adjust the screen sharpness.
Command Structure
[k][k][][Set ID][][Data][CR]
Data Min: 00 to Max: 32
Acknowledgment
[k][][Set ID][][OK/NG][Data][x]
11. OSD Select (Command: k l)
To select OSD (On Screen Display) status when controlling remotely.
Command Structure
[k][l][][Set ID][][Data][CR]
Data 00: OSD Off 01: OSD On
Acknowledgment
[l][][Set ID][][OK/NG][Data][x]
12. Remote Control Lock Mode (Command: k m)
To lock both the display panel button functions and remote control IR features.
Command Structure
[k][m][][Set ID][][Data][CR]
Data 00: Lock Off 01: Lock On
Acknowledgment
[m][][Set ID][][OK/NG][Data][x]
- If the TV is turned OFF by Off timer or “ka” or “mc” command) while Remote Control Lock Mode is on, it is not possible to turn the TV back ON via the POWER key on the display panel or the remote control.
 - When the TV’s AC power is removed/disconnected and then reapplied, Remote Control Lock is released.
13. Balance (Command: k t)
To adjust sound balance.
Command Structure
[k][t][][Set ID][][Data][CR]
Data Min: 00 to Max: 64
Acknowledgment
[t][][Set ID][][OK/NG][Data][x]

Reference: TLT Communication Parameters (Cont.)

14. Color Temperature (Command: x u)

To adjust color temperature.

Command Structure

[x][u][][Set ID][][Data][CR]

Data Min: 00 to Max: 64

Acknowledgment

[u][][Set ID][][OK/NG][Data][x]

15. Equalizer (Command: j v)

To adjust EQ of the TV.

Command Structure

[j][v][][Set ID][][Data][CR]

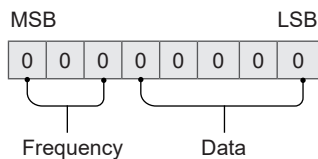

7	6	5	Frequency	4	3	2	1	0	Step
0	0	0	1st Band	0	0	0	0	0	0 (decimal)
0	0	1	2nd Band	0	0	0	0	1	1 (decimal)
0	1	0	3rd Band	-	-	-	-	-	-
0	1	1	4th Band	1	0	0	1	1	19 (decimal)
1	0	0	5th Band	1	0	1	0	0	20 (decimal)

Acknowledgment

[v][][Set ID][][OK/NG][Data][x]

Depends on model and can be adjusted when sound mode is EQ adjustable value.

16. Tune Command (Command: m a)

To tune the channel to the following Physical Major/Minor Channel number.

Command Structure

[m][a][][Set ID][][Data0][][Data1][][Data2][][Data3][][Data4][][Data5][CR]

- Analog Antenna/Cable

[Data0]: Physical Channel number

- Antenna (ATV): 02–45 (Decimal: 2–69)
- Cable (CATV): 01–7D (Decimal: 1–125)

[Data1–4]: Major/Minor Channel number

- Data1 & Data2: xx (Don't care)
- Data3 & Data4: xx (Don't care)

[Data5]: Input Source (Analog)

- 00: Antenna (ATV)
- 01: Cable (CATV)

- Digital Antenna/Cable

[Data0]: Physical Channel number*

- Antenna (DTV): 02–45 (Decimal: 2–69)
- Cable (CADTV): 01–87 (Decimal: 1–135)

* When [Data5] is 22, 26, or 66 (see below), use 00 for [Data0].

[Data1][Data2]: Major Channel number

- Data1: High byte Channel Data
- Data2: Low byte Channel Data
00 01–27 0F (Decimal: 1–9999)

[Data3][Data4]: Minor Channel number

- Data3: High byte channel data
- Data4: Low byte channel data
00 00–03 E7 (Decimal: 0–999)

[Data5]: Input Source (Digital)

- 02: Antenna (DTV), Use Physical Channel number
- 06: Cable (Auto**) (CADTV), Use Physical Channel number
- 22: Antenna (DTV), Do not use Physical Channel number (see also [Data0] * above)
- 26: Cable (Auto**) (CADTV), Do not use Physical Channel number (see also [Data0] * above)
- 46: Cable (Auto**) (CADTV), Use Physical Major Channel number only (One Part Channel)
- 66: Cable (Auto**) (CADTV), Use Major Channel number only (One Part Channel), Do not use Physical Channel number (see also [Data0] * above)

** Cable bands Cable Std - 3, Cable HRC - 4, and Cable IRC - 5 can also be used in [Data5] lower nibble.

Two bytes are available for each Major and Minor Channel number. The high byte is 00 unless the channel number exceeds 255.

Tune Command Examples:

Example 1: Tune to analog cable channel 35

Set ID = All = 00
Data0 = Channel Data is 35 = 23
Data1 & Data2 = No Major = 00 00
Data3 & Data4 = No Minor = 00 00
Data5 = Analog Cable = 01
Total = ma 00 23 00 00 00 00 01

Example 2: Tune to digital antenna channel 30-3

Set ID = All = 00
Data0 = Don't know Physical = 00
Data1 & Data2 = Major is 30 = 00 1E
Data3 & Data4 = Minor is 3 = 00 03
Data5 = Digital Antenna = 22
Total = ma 00 00 00 1E 00 03 22

Reference: TLT Communication Parameters (Cont.)

Acknowledgment

```
[a][ ][Set ID][ ][OK][Data 0][Data1]
[Data2][Data3][Data4][Data5][x]
[a][ ][Set ID][ ][NG][Data0][x]
```

17. Channel Add/Delete (NTSC) (Command: m b)

To set the saved channel status.

Command Structure

```
[m][b][ ][Set ID][ ][Data][CR]
```

Data 00: Delete
01: Add

Acknowledgment

```
[b][ ][Set ID][ ][OK/NG][Data][x]
```

18. Key (Command: m c)

To send IR remote key code.

Command Structure

```
[m][c][ ][Set ID][ ][Data][CR]
```

Data Key code. See Key Codes table on page 93.

Acknowledgment

```
[c][ ][Set ID][ ][OK/NG][Data][x]
```

19. Control Backlight (Command: m g)

To control the backlight.

Command Structure

```
[m][g][ ][Set ID][ ][Data][CR]
```

Data Min: 00 to Max: 64

Acknowledgment

```
[g][ ][Set ID][ ][OK/NG][Data][x]
```

20. Input select (Command: x b)

To select input source for main picture.*

Command Structure

```
[x][b][ ][Set ID][ ][Data][CR]
```

Data	00: DTV	01: CADTV
	02: Satellite DTV	10: ATV
	11: CATV	
	20: AV or AV 1	21: AV 2
	40: Component 1	41: Component 2
	60: RGB	
	90: HDMI 1	91: HDMI 2
	92: HDMI 3	93: HDMI 4

Acknowledgment

```
[b][ ][Set ID][ ][OK/NG][Data][x]
```







* This function depends on model and signal.

Reference: TLT Communication Parameters (Cont.)

Key Codes

The following table provides key codes for a typical LG Installer Remote.

Note: Some keys are not applicable to all models.

Code (Hexa)	Function	Code (Hexa)	Function
00	CH ^ PAGE ↑	C0	 (Green)
01	CH v PAGE ↓	C1	 (Red)
02	VOL +	C2	 (Yellow)
03	VOL -	C3	 (Blue)
06	>	8E	▶▶
07	<	8F	◀◀
08	POWER ⏻ (toggle)	C4	POWER ON
09	MUTE/DELETE	C5	POWER OFF
10–19	Numbers (0–9)	B0	▶
28	BACK ↵	B1	■
39	CC CHAR/NUM	BA	
40	^	AA	INFO ⓘ
41	v	AB	GUIDE
43	MENU SETTINGS	7C	SMART
44	OK/ENTER Ⓞ	7E	 eMPLink
0A	SAP	DC	 3D/*
0B	INPUT	60	PIP/*
0C	PORTAL	61	PIP INPUT/*
0E	TIMER	63	SWAP/*
1A	FLASHBK	71	PIP CH +/*
4C	—	72	PIP CH -/*
5B	EXIT	79	RATIO
		91	VD/*

Troubleshooting

General Troubleshooting

Some Quick and Easy Tips for Resolving Problems

Installation

Symptom	Possible Cause(s)	Possible Solution(s)
Cannot direct enter channel number.	(TV in Pass-through Mode) Installer Menu item 028 CH. OVERRIDE is set to 0, i.e., disabled (recommended setting).	If Installer Menu item 028 CH. OVERRIDE is set to 0, only channels that are active in the TV's channel lineup can be selected. Set CH. OVERRIDE to 1 to allow access for direct keypad entry to all channels.
	(TV not in Pass-through Mode) The channel entered is not included in the applicable Channel Map.	Channel access is restricted to channels included in the applicable Channel Map, for example the FTG Channel Map if the TV is in FTG Mode or the Pro:Centric Direct Channel Map if the TV is in Application Tuning Mode with Pro:Centric Direct. If necessary, make changes to the Channel Map using the appropriate application/content editor.

Picture Reception and Sound

Symptom	Possible Cause(s)	Possible Solution(s)
No picture.	TV is turned OFF.	<ul style="list-style-type: none"> • Turn TV ON. • Power failure?
	Antenna/cable not connected.	Connect antenna/cable signal to TV.
	Connections incorrect.	Check connections on TV.
	MPI not connected.	If applicable, connect MPI cable to MPI device.
	Encrypted program.	Try another channel.
	Wrong tuning band.	Adjust Installer Menu settings.
Normal picture, poor or no sound.	Audio muted.	Press MUTE or use Volume Up key to increase sound level.
	Broadcast problem.	Try a different channel.

Erratic Operation

Symptom	Possible Cause(s)	Possible Solution(s)
Installer Menu setup.	Wrong Installer Menu settings.	Adjust Installer Menu settings as required.

Installer Remote

Symptom	Possible Cause(s)	Possible Solution(s)
Remote doesn't work.	Remote not in TV Mode.	Use MODE key to select "TV"; puts remote into TV Mode.
	Not aimed at IR receiver.	Point remote at IR receiver on TV.
	Remote too far from IR receiver or IR path is obstructed.	Move remote closer to IR receiver on TV, darken room, and/or remove obstructions.
	MPI not connected.	If applicable, connect MPI cable to MPI device.
	Weak batteries.	Replace batteries.
	Wrong battery polarity.	Check that "+" and "-" match in battery compartment.
	Too much light in room.	Dim room light.
	Wrong Installer Remote.	Requires compatible LG Installer Remote. Contact your LG representative.

Commercial Mode Check / FTG Operation Troubleshooting

Commercial Mode Check

Use this flowchart to determine whether the TV is currently in Commercial Mode.

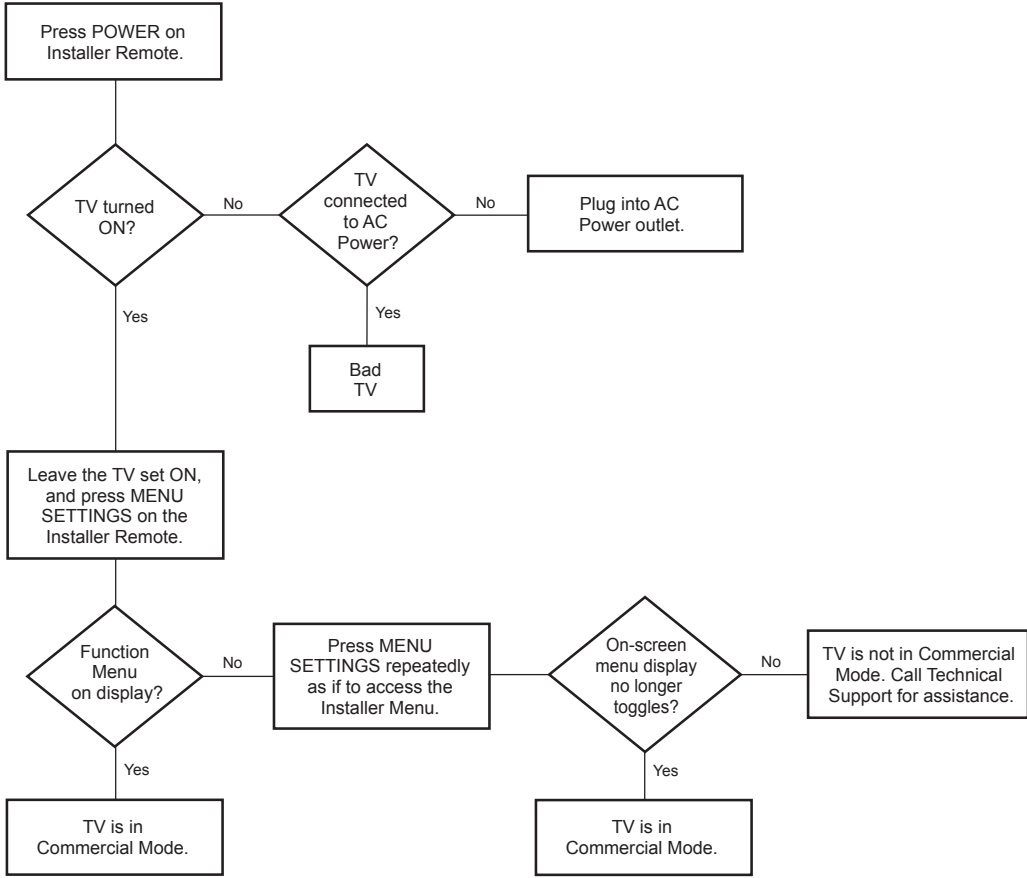

FTG Operation Troubleshooting

The following table provides troubleshooting information for when the EBL is configured for FTG Mode operation.

Symptom	Possible Cause(s)	Solution(s)
Communication Error ("Communications Timeout")	Cable(s) not connected.	Check and connect communication cables.
	TV not powered.	Check/connect the TV power cord.
	TV not turned ON.	TV needs to be turned ON (default setting of Installer Menu item 118 POWER SAVINGS).
	Wrong COM (communication) port.	In the FTG Device Configuration Application, select the correct COM port for the cable being used.

Glossary of Terms

Application Tuning Mode

LG commercial TV mode that enables the TV's Channel Map to reside in a Pro:Centric application.

b-LAN

SONIFI Solutions, Inc. proprietary RF communication system used to configure/control TV via RF distribution system.

Basic Settings Wizard

Lodging model TV configuration wizard that provides basic settings options. Includes Channel Tuning.

Channel Lineup

Channels set in the TV memory, via Auto Tuning/manual editing.

Channel Map

Typically refers to a logical channel mapping of physical channels (for example, an FTG Channel Map). This allows digital channels, like analog channels, to be tuned without requiring the dash key. Also, channels (analog or digital) can be arranged in any order that seems logical for customer tuning/viewing.

Cloning

The process of capturing a Master TV Setup and transferring it to a Target TV using a USB memory device.

Commercial Mode

A mode of operation that provides a broad range of commercial TV features based on control (settings) provided by the PTC and/or an MPI control device.

CPU

The TV's Central Processing Unit. Responsible for the presentation of video and audio from content received via the TV's tuner or Aux inputs.

EBL

Embedded *b*-LAN module. See also *b*-LAN.

E-Z Installation

Enables boot logo image, TV configuration, and software file downloads to selected TV models from a Pro:Centric server. Managed and administered via the appropriate Pro:Centric Admin Client.

EZ-Manager Wizard

Lodging model TV configuration wizard that provides configuration options for Pro:Centric operation as well as an option for using a USB memory device to configure a TV.

FTG Mode

LG commercial TV mode that enables decryption of Pro:Idiom encrypted channels and logical channel mapping. Implementation and TV operation is based on the "owner" of the FTG Channel Map—the CPU or the EBL. TVs may be configured locally using LG's proprietary applications or remotely using an applicable head end device.

Function Menu

Available via Installer Remote "MENU" key. Indicates the TV is not in Pass-through Mode. Restricts menu options to a subset of the TV setup menus, allowing users to retain functional control, while disabling setup options.

Installer Menu

Defines commercial TV functionality based on the parameters set.

LG Free-To-Guest (FTG)

Refers to a particular commercial mode of operation within an LG TV. See also FTG Mode.

Logical Channel Number

A number assigned to either a physical or virtual channel number in a Logical Channel Map.

Major Channel Number

Typically, the RF channel number assigned to a digital video stream.

Master TV

A TV whose Channel Map and Installer Menu and TV setup menu settings have been configured as a Master TV Setup for cloning purposes.

Minor Channel Number

A sub-channel or program number assigned to the content embedded in the digital video stream.

MPI

Multiple Protocol Interface. An MPI port or, for some TV models, an MPI card slot provides external control options for solution providers.

Pass-through Mode

The TV's factory default mode of operation. TVs can be configured for stand-alone use or as Master TVs for cloning purposes, and/or TVs may be controlled externally in this mode.

Physical Channel Number

The major channel number assigned to represent a specific 6 MHz RF band as specified by either the broadcast or CATV channel plan. See CEA (formerly EIA) or NCTA specifications for further information.

Pro:Centric Application

LG content delivery and communication interface powered by a Pro:Centric server, that provides interactive entertainment, weather, amenities, etc. information for end users. Two application options are available: Pro:Centric Java application or Pro:Centric Direct HTML application.

Pro:Centric Admin Client

Web editor/content wizard provided for service provider and customer configuration of Pro:Centric application and management elements. The proper Admin Client must be used in accordance with licensed (Java or HTML) application.

Pro:Idiom

Zenith proprietary security software that unlocks access to premium content to help assure rapid, broad deployment of HDTV and other high-value digital content.

PTC

Protocol Translation Controller. The commercial controller (microprocessor) of the commercial TV.

Target TV

A TV to which a Master TV Setup will be transferred.

TV Setup Menus

Available via Installer Remote "MENU" key in Pass-through Mode only. Menus provide access to TV setup and functional features.

USB Memory Device

A USB flash drive or USB storage device, etc. that can be used for TV configuration purposes (typically cloning or FTG Mode via CPU configuration) or for updating TV software.

Virtual Channel Number

An alias (virtual) channel number provided in the data stream, by the broadcaster, of a digital broadcast channel to be displayed by consumer TVs in place of the physical channel number. The major number is the same as the original analog channel number and the minor number is the nth program available in that digital video stream.

Document Revision History / Open Source Software Notice

Document Revision History

Date	Description
April 2019	Revision A: New document
September 2019	Revision B: UT577H information added
July 2021	Revision C: 50" model, 9UA, and Installer Menu updates

Product documentation is available online at: www.lg.com/us/business.

Open Source Software Notice

To obtain the source code under GPL, LGPL, MPL and other open source licenses, that is contained in this product, please visit <http://opensource.lge.com>. In addition to the source code, all referenced license terms, warranty disclaimers and copyright notices are available for download. LG Electronics will also provide open source code to you on CD-ROM for a charge covering the cost of performing such distribution (such as the cost of media, shipping and handling) upon e-mail request to opensource@lge.com. This offer is valid for three (3) years from the date on which you purchased the product.



For Customer Support/Service, please call:

1-888-865-3026

www.lg.com/us/business

Pro:Idiom is a registered trademark of Zenith Electronics LLC. Pro:Centric and the "LG" logo are registered trademarks of LG Electronics Inc. b-LAN is a trademark of SONIFI Solutions, Inc. All other trademarks or registered trademarks are the property of their respective owners.